

RADIO'S LIVEST MAGAZINE

OVER 175 ILLUSTRATIONS

Radio-Craft

★

**SPECIAL
RADIO
EXPERIMENTER
NUMBER**

December

25 Cents

*in United States
and Canada*

HUGO GERNSBACK EDITOR



**A NEW
TELEVISION TUBE
IS BORN!**

See Page 335

**Radio's Golden Jubilee!—Radio Circuits Analyzed—Fun with Radio Parts
Army Plane Lands Without Pilot!—4-Tube Set for "Advanced Beginners"**

OVER 50,000 RADIO MEN READ RADIO-CRAFT MONTHLY

Now! RAZOR-EDGE SHADOW TUNING-

in an
amazing new
SUPREME
SIGNAL
GENERATOR!

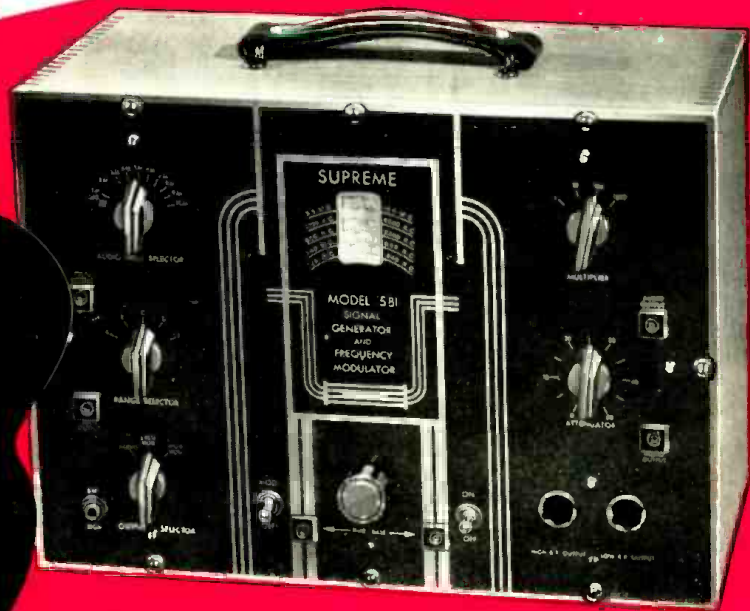

- (ABOVE) **MODEL 581 Signal Generator** — Dealer's Net Wholesale Cash Price..... \$54.95
On S. I. C. Payment Plan: \$6.00 Cash and 10 monthly payments of \$5.44

SUPREME'S newest contribution to radio science—the new 581 Signal Generator! Full of the outstanding precision features found only in laboratory types selling as high as \$600! Over 8 feet of actual scale length! New razor-edge shadow tuning eliminates all possibility of Parallax error!

Includes an all-wave R. F. oscillator—125 K. C. to 60 MC; a 400 cycle modulating oscillator, a beat frequency audio frequency oscillator, an electronic frequency modulator or "wobulator", and dozens of other exclusive, outstanding Supreme features. Complete with four tubes, shielded dummy antenna, calibrated screen for 3" C. R. tube and accessories. Dimensions: 14"x10⁵/₈"x6³/₄".

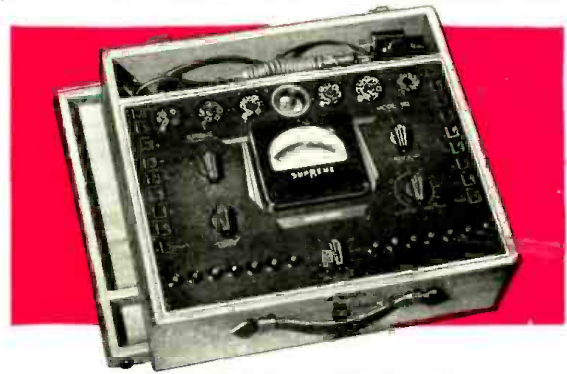

MODEL 502 Tube and Radio Tester

Imagine having five tests for every tube PLUS nineteen additional ranges and functions of 0.2 to 1400 A. C. volts in four ranges; 0.1 ohms to 20 megohms in five ranges; 0.2 to 1400 A. C. volts in four ranges; 0.2 to 1400 A. C. volts in four output ranges PLUS an Electrostatic capacity leakage test on a neon bulb and PLUS an Electrolytic filter capacity leakage test on a "Good-Bad" English reading scale. A Complete quality tube tester and set tester in a space 10¹/₂ in. x 5 in. weighing only 16 lbs. at this new low price!

Dealer's Net Cash Price..... \$49.95
Or, \$5.50 cash and 10 monthly payments of \$4.95

SOLD ON SUPREME S. I. C. TERMS—THE WORLD'S EASIEST INSTALLMENT TERMS. WRITE FOR LITERATURE DESCRIBING COMPLETE SUPREME LINE.

SUPREME INSTRUMENTS CORP.

GREENWOOD, MISSISSIPPI, U. S. A.

EXPORT DEPT., ASSOCIATED EXPORTERS CO., 145 W. 45th STREET, NEW YORK CITY. CABLE ADDRESS: LOPREH, NEW YORK



J. E. SMITH
President
National Radio
Institute
Established 1914
The man who has
directed the
home study training
of more men
for the Radio industry
than any
other man in
America.

I WILL TRAIN YOU TO START A SPARE TIME OR FULL TIME RADIO SERVICE BUSINESS WITHOUT CAPITAL

**HERE ARE A FEW EXAMPLES
OF THE KIND OF MONEY
I TRAIN MY MEN TO MAKE**



**\$200 TO \$300 A MONTH IN OWN
BUSINESS**

"For the last 18 months I have been in business for myself, making between \$200 and \$300 a month. I have N.R.I. to thank for my start in this field."—**ARLIE J. FROEHLER**, 224 W. Texas Ave., Goose Creek, Texas.

OVER \$1,000 BEFORE GRADUATING

"Before completing half the N.R.I. Course I was servicing sets, and I made \$1,000 to \$1,200 before graduating. I am doing Radio service work for myself now."—**ASHLEY G. ALDRIDGE**, 1228 Shepherd St., Petersburg, Va.



**CHIEF OPERATOR BROADCASTING
STATION**

"When I completed 20 lessons, I obtained my Radio Broadcast Operator's License and immediately joined Station WMPC, where I am now Chief Operator."—**HOLLIS F. HAYES**, 85 Madison St., Lapeer, Mich.

**EARNINGS TRIPLED BY N.R.I.
TRAINING**

"I have been doing nicely, thanks to N.R.I. Training. My present earnings are about three times what they were before I took the Course. I consider N.R.I. Training the finest in the world."—**BERNARD COSTA**, 201 Kent St., Brooklyn, N. Y.



**Get My LESSON on
Radio Servicing Tips FREE**

I'll prove that my Training gives practical, money-making information, that it is easy to understand—that it is just what you need to master Radio. My sample lesson text, "Radio Receiver Troubles—Their Cause and Remedy" covers a long list of Radio receiver troubles in A.C., D.C., battery, universal, auto, T. R. F., superheterodyne, all-wave, and other types of sets. And a cross reference system gives you the probable cause and a quick way to locate and remedy these set troubles. A special section is devoted to receiver check-up, alignment, balancing, neutralizing, testing. You can get this lesson Free by mailing the coupon.



**MAIL
COUPON
NOW**

**The Tested WAY
to BETTER PAY**

Do you want to make more money? The world-wide use of Radio has made many opportunities for you to have a spare time or full time Radio service business of your own. Three out of every four homes in the United States have Radio sets which regularly require repairs, servicing, new tubes, etc. Servicemen can earn good commissions selling new sets to owners of old models. I will train you at home in your spare time to sell, install, service, all types of Radio sets to start your own Radio business and build it up on money you make in your spare time while learning. Mail coupon for my 64-page book. It's Free—it shows what I have done for others—what I am ready to do for you.

**Many Make \$5, \$10, \$15 a Week Extra
in Spare Time While Learning**

Almost every neighborhood needs a good spare time serviceman. The day you enroll I start sending you Extra Money Job Sheets. They show you how to do Radio repair jobs, how to cash in quickly. Throughout your training I send you plans and ideas that have made good spare time money—from \$200 to \$500 a year—for hundreds of fellows. I send you special Radio equipment and show you how to conduct experiments and build circuits which illustrate important Radio principles. My training gives you PRACTICAL EXPERIENCE while learning.

**There's a Real Future in Radio
For Well Trained Men**

Radio already gives jobs to more than 300,000 people. And in 1936, Radio enjoyed one of its most prosperous years. More than \$500,000,000 worth of sets, tubes and parts were sold—an increase of more than 60% over 1935. Over a million Auto Radios were sold, a big increase over 1935. 24,000,000 homes now have one or more Radio sets, and more than 4,000,000 autos are Radio equipped. Every year millions of these sets go out of date and are replaced with newer models. More millions need servicing, new tubes, repairs, etc. A few hundred \$30, \$50, \$75 a week jobs have grown to thousands in 20 years. And Radio is still a new industry—growing fast!

**Get Ready Now for Your Own Radio Business
and for Jobs Like These**

Radio broadcasting stations employ engineers, operators, station managers and pay up to \$5,000 a year. Spare time Radio set servicing pays as much as \$200 to \$500 a year—full time jobs with Radio jobbers, manufacturers and dealers, as much as \$30, \$50, \$75 a week. Many Radio Experts own and operate their own full time or part time Radio sales and service businesses. Radio manufacturers and jobbers employ testers, inspectors, foremen, engineers, servicemen, paying up to \$6,000 a year. Radio operators on ships get

good pay, see the world besides. Automobile, police, aviation, commercial Radio, loud speaker systems are newer fields offering good opportunities. Television promises to open many good jobs soon. Men I have trained are holding good jobs in these branches of Radio. Read their statements in my 64-page book. Mail the coupon.

**I GIVE YOU A PROFESSIONAL
SERVICING
INSTRUMENT**



Here is the instrument every Radio expert needs and wants—an All-Wave, All-Purpose, Set Servicing Instrument. It contains everything necessary to measure A.C. and D.C. voltages and current; test tubes, resistance; adjust and align any set, old or new. It satisfies your needs for professional servicing after you graduate—can help you make extra money servicing sets while training.

**Save Money—Learn At Home
Money Back Agreement Protects You**

I am sure I can train you at home successfully. I will agree in writing to refund every penny you pay me if you are not satisfied with my Lessons and Instruction Service when you finish my Course. I'll send you a copy of this agreement with my Book.

**Find Out What Radio Offers You
Get My 64-Page Book Free Now**

Act Today. Mail the coupon now for my Free Lesson and my book, "Rich Rewards in Radio." Both are free to anyone over 16 years old. My book points out Radio's spare time and full time opportunities and those coming in Television; tells about my Training in Radio and Television; shows you letters from men I have trained, telling what they are doing and earning. Find out what Radio offers YOU! MAIL THE COUPON in an envelope, or paste it on a penny post card—NOW!

**J. E. SMITH, President
National Radio Institute,
Dept. 7NX
Washington, D. C.**

**THIS
FREE BOOK
HAS HELPED
HUNDREDS OF
MEN MAKE
MORE
MONEY**



**GOOD FOR BOTH 64 PAGE BOOK
SAMPLE LESSON FREE**

J. E. SMITH, President, National Radio Institute, Dept. 7NX, Washington, D.C.

Without obligating me, send your Lesson "Radio Receiver Troubles—Their Cause and Remedy" and free book about spare time and full time Radio opportunities and how I can train for them at home in your spare time—about the N.R.I. Set Servicing Instrument you give me. I am particularly interested in the branch of Radio checked below.

- | | |
|---|--|
| <input type="checkbox"/> Radio Service Business of My Own | <input type="checkbox"/> Loud Speaker Systems, Installations and Service |
| <input type="checkbox"/> Spare Time Radio Service Work | <input type="checkbox"/> Auto Radio Installation and Service |
| <input type="checkbox"/> Retail Sales of Radio sets and Equipment | <input type="checkbox"/> Television Station Operator |
| <input type="checkbox"/> Service Expert for Retail Stores | <input type="checkbox"/> Service Expert with Radio Factory |
| <input type="checkbox"/> Broadcasting Station Operator | <input type="checkbox"/> Commercial Radio Station Operator |
| <input type="checkbox"/> Aviation Radio Operator | <input type="checkbox"/> All-around Serviceman Expert |
| <input type="checkbox"/> Ship Radio Operator | |

(If you have not decided which branch you prefer—mail coupon now, for information to help you decide.)

NAME AGE

ADDRESS 14X1



HUGO GERNSBACK, Editor-in-Chief
 N. H. LESSEM Associate Editor
 R. D. WASHBURNE, Managing Editor
 C. P. MASON Associate Editor

CONTENTS—DEC. 1937, ISSUE

Volume IX Number 6

Editorial: Modern Radio ExperimentationHugo Gernsback 325

The Radio Month in Review..... 326

Heinrich Hertz Proves Existence of Radio Waves!—
50 Years Ago..... 328

New Tubes for the Radio Experimenter—Part III
.....R. D. Washburne 329

Short-Wave Radio Lands Army Plane Without Human Aid!
.....Capt's C. J. Crone and G. V. Holloman 330

Radically New!—"Machine-Gun" Mike "Shoots"
American Legion Parade.....M. H. Gernsback 332

"Electric Eye" Protects Wild Game..... 333

How to Make the RADIO-CRAFT Super-DeLuxe
30-Tube Set—Part IIIB, I.F. Channels and Auto-
matic Control Circuits..... 334

Television Students Learn by Making Cathode-Ray
Tubes—Part IIU. A. Sanabria 335

New Console Utilizes "Bass Reflex".....Lewis Winner 335

Beginners!—Build This "Tiny Tim" 4-Tube Set
.....Raymond P. Adams 336

Fun with Radio Parts.....Walter Palmer 338

How Dependable Are Your Meter Readings?—
Part III.....Alfred A. Ghirardi 340

Luigi Galvani—200th Anniversary..... 341

New 20-Tube Set Introduces Distortionless A.F. Ex-
pansion.....Paul P. Smith 341

"Learn-by-Experimenting" Beginners' Practical Radio
Course—Experiment No. 3.....Sol D. Prenskey 342

How to Conduct a Sound-on-Film Recording Studio
—Part IB.....I. Queen 344

New Circuits in Modern Radio Receivers—No. 3
.....F. L. Sprayberry 345

Introducing—"Audio-Spectrum Control"
.....A. C. Shaney 346

"Snow Static" Being Beaten by "Flying Laboratory"
—Part II.....H. M. Hucke 348

Recent Applications of the "Electric Eye"—Part II
.....K. Guenter 349

Short-Cuts in Radio..... 350

How to Build the "Alarmclock" Wall-Radio Set—
Part II.....N. H. Lessem 351

New 15-W. Amplifier Features High Gain, Low Hum
Level.....G. McL. Cole 351

The Latest Radio Equipment..... 352

Servicing Questions & Answers..... 353

Operating Notes 353

RADIO SERVICE DATA SHEETS:
No. 217—Sparton Models 1068 and 1068X..... 354
No. 218—Ditto (continuation)..... 355

Radio Wittiquiz 356

ORSMA Members' Forum..... 356

Book Review 384

**JANUARY RADIO-CRAFT—
SPECIAL
SHORT-WAVE NUMBER!**

Another year rolls by and once again we dedicate the January issue of *Radio-Craft* to all short-wave enthusiasts, —not neglecting however the technicians in all the other branches of radio. Thus, a famous author (well known to our readers) in a special exclusive article, will give a very complete and interesting review of all the developments in short waves which have occurred during the year 1937. Many other articles of considerable importance will also appear in that issue. Don't miss the January issue! —on the newsstands December 1st.

Published by Radcraft Publications, Inc. Publication office: 29 Worthington Street, Springfield, Mass. Editorial and Advertising Offices: 99 Hudson Street, New York City. Chicago Advertising Office: L. F. McClure, 919 North Michigan Avenue, Chicago, Ill. Western Advertising Office: Loyd B. Chappell, 530 West Sixth St., Los Angeles, Calif.

Foreign Agents:
 London—Gorrings' American News Agency, 9A Green St., Leicester Square, W. C. 2, England.
 Paris—Messageries Dawson, 4 Rue Faubourg, Poissonniere, France.
 Melbourne—McGill's Agency, 179 Elizabeth St., Australia.
 Dunedin—James Johnston, Ltd., New Zealand.

RADIO-CRAFT is published monthly, on the first of the month preceding that of date; subscription price is \$2.50 per year in U. S. and Canada. (In foreign countries, \$3.00 a year to cover additional postage.) Entered at the post office at Springfield as second-class matter under the act of March 3, 1879.

Text and illustrations of this magazine are copyright and must not be reproduced without permission of the copyright owners.

Copyright 1937. Radcraft Publications, Inc.

MANY OPPORTUNITIES FOR THE COYNE TRAINED RADIO MAN

Are You Ready for a Better Job - More Pay?

Don't be an untrained man. Let me show you how to get your start in Radio — a fast growing, live money-making industry.

Prepare for jobs as Assembler, Inspector and Tester—Radio Sales or Service and Installation Work—Broadcasting Station Operator—Wireless Operator on a Ship or Airplane or Sound Work— **HUNDREDS OF OPPORTUNITIES** for a real future in radio!

12 Weeks of Shop Training

We don't teach by book study. We train you on a great outlay of Radio, Television and Sound equipment—on scores of modern Radio Receivers, actual Broadcasting equipment, Television apparatus and Sound Reproduction equipment, Code and Telegraph equipment, etc. You don't need advanced education or previous experience. We give you — **RIGHT HERE IN THE COYNE SHOPS** — the actual practice and experience you'll need for your start in this great field. And because we cut out all useless theory and only give that which is necessary you get a practical training in 12 weeks. Mail coupon for all facts about my school and training methods.

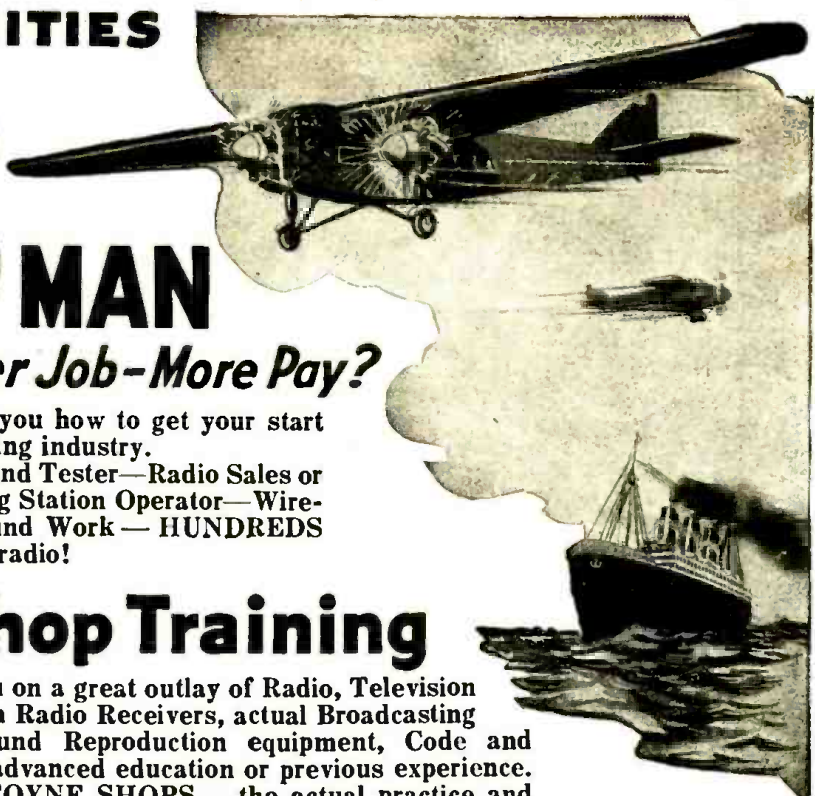

TELEVISION *and* PUBLIC ADDRESS

Television is sure to come as a commercial industry. Rapid progress is now being made in developing this new field. It will offer opportunities to the man who is trained in Radio. Here at Coyne you learn Television principles, and work on actual Television equipment. Public Address Systems offer opportunities to the Trained Radio Man. Here is a great new Radio field which is rapidly expanding. Prepare NOW for these wonderful opportunities! Learn Radio Sound Work at COYNE on actual Sound Reproduction equipment. Not a home study course.

SEND FOR DETAILS OF MY "PAY AFTER GRADUATION" PLAN

Mail the Coupon below and I'll tell you about my "Pay After Graduation" Plan which has enabled hundreds of others to get Coyne training with very little money. On this plan you can get your training first, then take 18 months to complete your small monthly tuition payments starting 5 months after you begin training. Not a home study course.

Mail the coupon for all details of this "Tuition Payment Plan."

PRACTICAL WORK at COYNE in Chicago

ACTUAL, PRACTICAL WORK. You build and service radio sets. You get training on real Broadcasting equipment. You construct Television Receiving Sets and actually transmit your own Television images over our Television equipment. You work on real Sound equipment. You learn Wireless Operating on Actual Code Practice apparatus. We don't waste time on useless theory. We give you the practical training you'll need for your start in Radio—in 12 short weeks. If you desire code, this requires additional time for which there is no extra charge.

Mail Coupon Today for All the Facts

H. C. LEWIS, Pres. RADIO DIVISION Founded 1899
Coyne Electrical School
500 S. Paulina St., Dept. 97-8H, Chicago, Ill.

ELECTRIC REFRIGERATION AIR CONDITIONING AUTOMOBILE ELECTRICAL WORK

Instruction now included at no extra cost. Here is your opportunity to learn these valuable allied lines without extra tuition charge.

PART TIME EMPLOYMENT TO HELP YOU "EARN WHILE LEARNING"

If you are short of money and need part time employment to help pay for your room and board while training, my Employment Department will help you get a part time job.



GET THE FACTS

Don't let lack of money prevent your sending in the Coupon. Mail the Coupon today and I Will send you the Big FREE Coyne Book full of FACTS.

H. C. LEWIS, Pres.

Radio Division, Coyne Electrical School
500 S. Paulina St., Dept. 97-8H, Chicago, Ill.

Dear Mr. Lewis:—Send me your Big Free Radio Book, and all details of your "Pay After Graduation" Plan including valuable instruction in Electric Refrigeration, Air Conditioning and Automobile Electrical Work.

Name.....

Address.....

City..... State.....

VOLUME VIII—JUST OFF THE PRESS



The Extra Features make VOL. VIII RIDER MANUAL An Even Greater Value . . .

In the manufacture of receiving sets—in the publishing business—yes, even in the servicing of radio sets, it's the extra services which put some businesses far above and away out in front of competition.

Today's radio sets are far more complicated than those of three years ago, especially in the construction outside of the radio circuit itself. Such things as motorized tuning, automatic frequency control and other standard improvements require information you must have if you are to be in a position to deliver the "extra" services which will get you the better—the more profitable business of your neighborhood.

So—this year with each copy of Volume VIII Rider Manual—with its over 1600 pages of circuit information on the sets of over a hundred manufacturers—there is supplied at no additional cost a section entitled "How It Works." This supplement is devoted to explanations of the mechanical as well as the electrical operations of the more complicated 1938 receivers and instruments.

Other needed information supplied by the Manual covers the installation and servicing of intercommunica-

tion systems, electronic musical instruments, and new P. A. amplifiers of all types.

To make all the facts of Volume VIII instantly available, the Index of about 118 pages covers all the information in all 8 volumes of Rider Manual.

And all this extra information is yours at no increase in price over last year's volume! Check your Rider Volumes and order any missing numbers today!

1. EXTRA PAGES—Over 1600 pages of complete servicing data on 1937-38 home and auto receivers. Complete because everything is included that more than 100 manufacturers gave us. For **COMPLETENESS** and **COVERAGE**—there's none better than Rider's Volume VIII.

2. EXTRA SUPPLEMENT—"How It Works"—A 64-page special section of Rider's Volume VIII devoted to explanations of the electrical and mechanical operations of the more complicated 1938 receivers and instruments . . . Principles and theory you need for profitable servicing.

3. EXTRA FACTS—Installation and servicing instructions for many types of intercommunication systems will be found in Rider's Volume VIII . . . Also servicing data on the electronic musical instruments (has never appeared in any other manual) . . . New Public Address Amplifiers of all types are included.

JOHN F. RIDER, Publisher
1440 BROADWAY
NEW YORK CITY

YOU NEED ALL 8
Rider
MANUALS

**JUST
OUT!**

**VOLUME VIII
\$10.00**

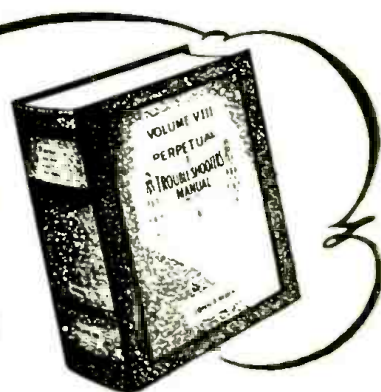



"Takes the Resistance out of Radio"

Editorial Offices: 99 Hudson St., New York, N. Y.

HUGO GERNSBACK, Editor

Vol. IX, No. 6, December 1937

MODERN RADIO EXPERIMENTATION

An Editorial by HUGO GERNSBACK

AS I HAVE mentioned often before, there is a good deal of confusion in the minds of many experimenters as to what *modern* "radio experimentation" really consists of.

Many newcomers jump to the conclusion that it means only the constructing of radio sets for either broadcast or short-wave work. Strictly speaking, radio experimenting is far more extensive and covers a really wide band of activity today. Of course, experimenting with new circuit adaptations, new tubes, and new radio instrumentalities will always find a warm niche in the heart of every real radio experimenter. A variety of new and better tubes as well as new radio components make new experiments always possible, and give new results as well. Even the lowly *crystal set* has its adherents and new stunts are being tried all the time, not only to increase the range but to make the tuning more selective. While experiments in this particular line have not developed much that is new in the past few years, some little progress is being made.

Even the classic *regenerative sets* which we used in the middle '20's are still being improved. *Double-regeneration circuits* are giving good results here and provide new interest in this almost forgotten circuit. The newer and more sensitive tubes, which are making their appearance right along, also mean increased experimentation with 2-, 3- and 4-tube sets. The day will come when we will have excellent 2-tube *superheterodyne receivers* and, if the present trend in tubes keeps up, this experimenter's dream will be fully realized within the next few years. Of course, we have already had 1-tube superheterodynes, and 2-tube sets too are not unknown, but their circuits were usually unstable and, as a rule, inefficient.

The once so-called "mystery circuit," or *super-regeneration*, invented by Major Armstrong, is also a fertile source of experimentation. While the circuit, so far, has not been efficient, because of the high-pitched whistle emanating from the speaker, it has been used successfully in short-wave work. The super-regenerator still holds much promise and we will soon see, in the newer tubes now coming on the market, entire suppression of the high-pitched whistle. So much for receiving sets—although I could fill several pages on this subject alone.

In the Public Address field, a tremendous amount of work still remains to be done and, for experimentation, this is still one of the most fertile fields, and one which no radio experimenter should overlook. Experimentation with the new Inter-Phones, or so called "*Private Address*" Systems, is one of the best fields for experimenters today. Indeed, many experimenters today are obtaining a considerable

amount of amusement by adapting their own sets to 2-way communication, without making many changes in the existing circuits of their home radio receivers.

The branch of radio called *electronics*, particularly that portion of it which concerns photoelectric cells, for some reason or other has been sadly neglected by thousands of experimenters; although we have here a tremendous field where a huge amount of work still remains to be done. Daily, new applications of the photoelectric cell with radio instrumentalities are brought about in a field so vast and so great that in time it will be larger than the present radio industry. Indeed, an official U. S. Government report from Washington ("*Technological Trends and National Policy*," compiled by the subcommittee on Technology of the National Resources Committee) states that here is one field that will help to revolutionize our present trends. It holds great possibilities for the future.

The photoelectric cell makes possible many labor-saving devices, and many safety devices in industrial applications; and it might be said that in this respect the surface has not even been scratched, because thousands of industries have not yet taken advantage of the possibilities of the photoelectric cell. It must also be added that there is hardly an industry in existence which cannot use these cells, in one way or another, to increase profits and cut down part of their present high labor costs!

To the newcomer in radio, experiments with radio components open up a new and veritable paradise of amateur research. I refer to experiments which deal with radio parts and radio instrumentalities alone. With all the modern radio devices that can now be procured at low cost, many electrical and other experiments can be performed by means of these instrumentalities. To understand better what I mean, let me mention just a few. Under the present radio law you cannot operate for experimental purposes, without a station license, a *radio telephone* in which an oscillating radio tube circuit is used. There is nothing to prevent you however from building an induction type of "wireless" phone, as for instance one design which requires at the transmitter only a microphone, battery and wire-filled wooden bicycle-rim, where radio tubes may be used to amplify the weak currents at the receiving end; a duplicate coil and a pair of headphones (and perhaps a single stage of audio amplification) being the only "receiver" needs.

Efficient *burglar-alarms* can easily be rigged up by using radio parts. "*Treasure*" finders, using the ancient but efficient Hughes induction balance, with audio amplifiers have never been experimented with as much as they deserve. The list of experiments of this type is limitless.

THE RADIO MONTH



(Photo—Universal Microphone Co.)

World's largest "mike" used last month, not for heel-drumming, but for world's largest bridge tournament and other events at Inglewood, Calif. Private-address phones linked 1,500 bridge players, at tables in streets.

TELEVISION NOW OUT ON THE CORNER

WITH the announcement last month by NBC that it is putting in commission a new motorized mobile television station, to pick up outdoor scenes and current events, it is evident that television has arrived; though the first work must be to acquire technique. One van, with Iconoscope cameras, will do the pick-up; and a second, cable-linked, will broadcast to the Empire State Building station, New York City.

In England, television is being applied to help the deaf—not those so born, but those who have lost their hearing—and last month saw a General Electric (British) television set with amplifying headphones installed in a home for the deaf to work out its possibilities. "One ex-soldier has heard for the first time since the War," reports *Reynolds' News*.

Television consultants are among the few foreign experts still welcome in Russian industry, reports Webb Miller, U.P. correspondent, just arrived from the Soviet Union.

"Television will revolutionize teaching from the kindergarten in no time at all—this time, next year. Sanely exploited, it will result in special curricula of great value," John L. Baird, Scots television pioneer, said to *The Passing Show* last month.

"Television problem from now on," Harold H. Beverage told the I.R.E. on the Pacific Coast last month, "is a program problem. It would be very costly to cast and train a group of actors for one night's performance. This is now facing us."

RADIO SCHOOLMARM AND TRAFFIC COP

IN the face of an epidemic which closed Chicago schools last month, radio took up the work of instruction. Newspapers printed summarized texts of the day's work, and 6 radio stations gave air time to teachers who addressed classes of pupils sitting in their homes! Examinations will check up on truants who tuned in jazz; but allowance will be made for pupils in radioless homes. Perhaps next year's school attendance laws will require a set in every home.

When car radio first appeared, many traffic authorities advocated its prohibition. But, with holiday traffic congestion at its worst last month, Pennsylvania's motor police announced that it would route traffic by radio; using 6 planes to watch highway conditions, and relaying advice about the least congested roads to broadcast stations, which would advise motorists through their car sets.

The American Legion parade of last month completely cut apart New York's famous East Side-West Side, for 18 hours. To meet the situation, the police put into operation 2-way radio transmitters, communicating from inspectors' transmitter-equipped cars, and mobilized reserves wherever confusion arose.

And, while radio has been a B.O. (box-office) bugaboo, *Variety* reports that during the Louis-Farr debate last month, many fight fans who had been listening on their car-radio sets drove up to buy tickets and see the contest, because it sounded interesting. Promoters of sporting events please note!

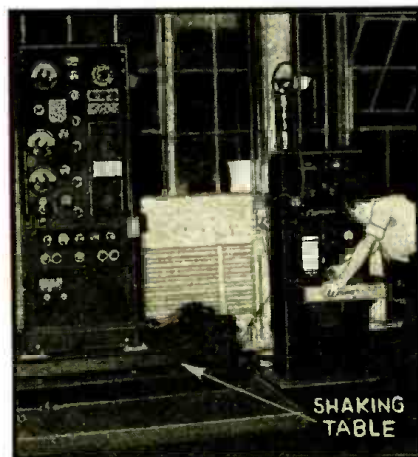

(Photo—General Electric Co.)

Radio equipment being given the 3rd degree by vibration ("So you won't fade!") on shaking table installed last month; a stroboscope, with controlled frequency of light flashes, permits vibrating parts to be examined as though standing still, in this big radio testing laboratory. Like this "shaking table," the "flight room" shown below helps test "plane-radio equipment."

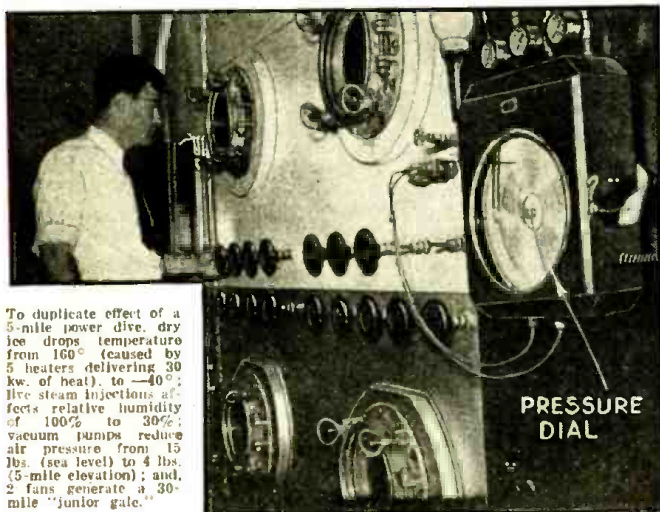

To duplicate effect of a 5-mile power dive, dry ice drops temperature from 160° (caused by 5 heaters delivering 30 kw. of heat), to -40°; live steam injections affect relative humidity of 100% to 30%; vacuum pumps reduce air pressure from 15 lbs. (sea level) to 4 lbs. (5-mile elevation); and, 2 fans generate a 30-mile "junior gale."

(Photo—General Electric Co.)

This "iron lung" is intended, not to save children from paralysis, but to give paralysis to aviation-radio sets, experimentally. In this cylinder, air can be lowered to stratosphere cold and thinness, and then raised to sea-level conditions, as though a pilot had dived from a height of 30,000 ft!



(Photo—C. J. Taclabue Mfg. Co.)

Not just a permanent radio wave; the beauty seeker is having her hair done to a turn. Thermocouples in each curl are connected to a galvanometer inside the control; and its light-ray, thrown into a photocell, controls applied heat to within 1 degree of the desired temperature, through 2 relays.

IN REVIEW

INDIANA POLICE-RADIO NETWORK GETS WQFW "FORTRESS"

INTRASTATE broadcasting may be facilitated by the success of the Chesterton, Indiana, State Police station, reported last month to be nearing completion as a W.P.A. project. The station (see map) is located in the northwest corner; and will have two 154-ft. towers; one to reflect signals back into Indiana, instead of spreading them over Lake Michigan.

The State Police radio network, costing approximately \$100,000, has the first 2 fortified radio stations in the United States (see photo of second). They are raid-proof, and the grounds are protected by 8 floodlights, and by barbed wire; the single entrance gate is remote-controlled electrically from inside the building! The radio operator and station attachés are equipped with high-calibre rifles; a 24-hour radio watch is maintained inside their solid-brick, bullet-proof citadel. During a man-hunt the dispatchers at Indianapolis headquarters can correlate all law enforcement agencies in Indiana and adjoining states. (In addition to Indiana 13 states have State Police radio facilities of one form or another.)

Short-wave receiving sets, locked-in to the 1,634 kc. State Police frequency, have been installed in the 92 sheriffs' offices in the state, in 50 police department headquarters, in all state police posts and motor equipment, as well as in a great number of banks, garages,

Radio is now such a vast and diversified art it becomes necessary to make a general survey of important monthly developments. RADIO-CRAFT analyzes these developments and presents a review of those items which interest all.

filling stations, and in the headquarters of numerous town authorities. Many cities in Indiana have 2-way short-wave communication with the network; other cities, operating ultra-short-wave 2-way systems instead, can only listen (on an auxiliary short-wave receiver) but can reply by telegraph or telephone.

RADIOVERSEA REPORTAGE

WHILE Japan's aircraft were jamming Chinese propaganda with bombs on Shanghai radio stations last month, the Japanese Imperial Government was undertaking to furnish radio sets to families of soldiers at the front.

Cheap radio sets from the States are regarded as a fire hazard by the Ontario Hydro-Electric Commission, Chief Test Engineer Dobson told reporters last month, and an attempt will be made to stop Canadian tourists from bringing them back home! And in India, after an improperly grounded aerial on a government-owned bungalow in Delhi was struck by lightning, the government has ordered all radio installations to be checked.

The Hebrides, northernmost of the British Isles, had their first radio pickup for broadcasting last month; when Secretary for Scotland Elliott announced from there that radio is to join them to the world's telephone system.

(Continued on page 369)



Exterior view of Paulists' 2-room, 20-ft. chapel-on-wheels.



The Service Man, in devout attitude is really giving last touches to the phono and "talkies" equipment of the motorized chapel, which left New York last month for a 7,000-sq. mile missionary parish in Tennessee. Seats on each side are for wet-weather services.



(Photo—W.P.A. Information Service)

Radio station WQFW, of the Indiana State Police, at Columbia City, is built like a fortress, with windowless walls, rifle portholes, and a bulletproof skylight. It has just been completed.



Outline map of Indiana, showing state police radio system, with 5 transmitters, now approaching completion on a permanent basis. Since temporary operations began, not only has there been 40% reduction in major crimes, but flood relief and other emergencies have found it is of great value. Station WQFW (see photo, left), like WDHE, defies any attempt of criminals or rioters to disable the system.

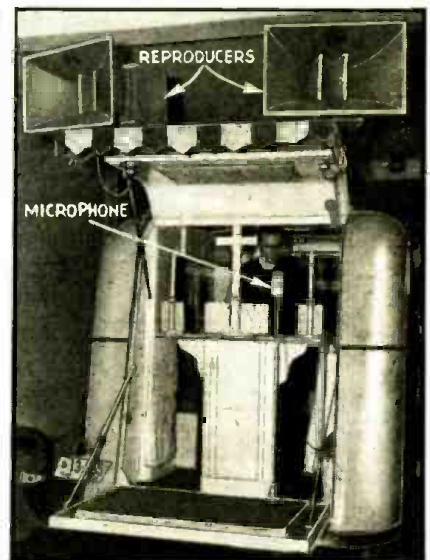

(Photos—Theodore N. Silberstein)

Father Halloran at microphone of the P.A. system used for outdoor services with the Paulist \$5,200 trailer chapel. Power is obtained from a generator in the coupe hauling the trailer.



Heinrich Hertz—1857-1894

The great Helmholtz said—when a successor to Hertz in the Chair of Physics at Bonn University was wanted—of his pupil: "There exists no rule under which a man of genius should be replaced by another in his own specialty." Hertz was born in Hamburg, Germany.

HEINRICH HERTZ PROVES EXISTENCE OF RADIO WAVES!

— 50 YEARS AGO

Having demonstrated, in 1887, the existence of the electromagnetic variations (forecast by Maxwell) which we today call radio waves he modestly wrote: "It is not for me to say whether the discovery I have made is truly wonderful, but it makes me very happy to know that other people say so."

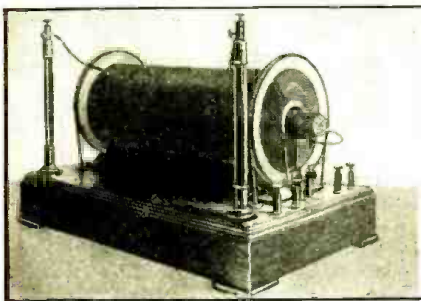

Funken-Induktor

The spark produced by this spark inductor or induction coil, Hertz found, radiated emanations the presence of which were capable of manifesting themselves at a distant point without the use of intervening wires or any other apparent means of direct connection. (Actually, the ether joined the sending and receiving "stations.")

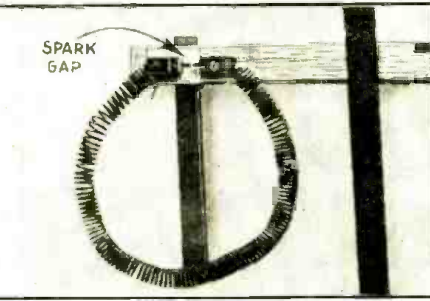

Resonator

World's first "radio receiving station"—and it is a short-wave (6-meter) set, at that! High self-inductance and capacity were obtained by winding wire into a compact spiral placed near the "sender"; the 2 terminals then were brought sufficiently close together to permit a spark to jump the gap.



Complete Sending and Receiving Station of the '80's!

Having found that a single piece of wire bent into the shape of a closed loop would spark-across at the gap when brought into the field of influence of a sparkcoil Hertz next tried increasing the effectiveness of the sparkcoil as a "sender" by connecting to its high-voltage terminals conductors having increasingly large area. Professor Hertz thus came to evolve among other types of antennas a long, tubular radiator consisting of parallel wires held in position by hoops.



(Photo.—H.P.S., Paris)

Schoolboy Hertz in 1865 Brought up in the highly intellectual atmosphere surrounding his father, a Jewish high magistrate, young Hertz at an early age exhibited exceptional interest in broad fields of learning (such as studying Greek classics in the original text, etc.) that helped develop his breadth of vision.

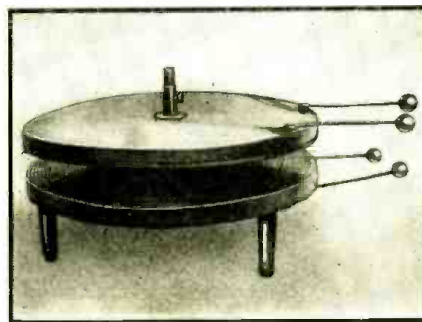

The "Knochenhauerschen Scheiben"

This "distributor of capacity" or fixed condenser (literal translation from the German) played an important part in the laboratory work of Heinrich Hertz. The device was made by winding 2 parallel wires, insulated from each other, to form a resonant circuit having high C/L ratio. Two such "pies" are shown.

THE TURNING of the third-quarter of the last century found scientists and other learned people preoccupied with the bewildering question "What is Light?" Various theories had been expounded without having satisfactory basis in fact or without having sufficient proof. At last in 1875 Clerk Maxwell asserted that light was the result of oscillations produced by an electromagnetic field existing somewhere in space and manifesting itself in the form of waves. Furthermore, he added, and proved mathematically that what was true for light was equally true for electricity. Whether or not Maxwell's theory was good remained to be proven.

Heinrich Hertz was the man who by his extraordinary experiments succeeded in demonstrating the truth of this theory thereby laying the basis for future experiments in electromagnetic waves and wireless (radio) communication.

He started with the principle in mind that all electric waves resulting from rapid electric oscillations could be propagated into the air in the same way as sound waves could be generated and propagated by causing a string or diaphragm to vibrate. He surmised correctly that electric waves had tremendous speed and vibrated at a terrific rate since they could be received, like light vibrations, at a distance from the place from whence they issued.

Hertz obtained his inspirations for his experiments from these various theories. He managed to produce electromagnetic waves with the simple apparatus here illustrated. Close examination of this apparatus in its fundamental aspects (the use of coils, condensers, etc.) reveals that it differs only in method (not in principle) from the present-day system of producing electromagnetic waves. Little did Hertz realize then that these same waves later on would be the instrumentality through which all the nations on the earth would be linked together more closely than by any other means. Physicists and radio engineers the world over

(Continued on page 368)

NEW TUBES FOR THE RADIO EXPERIMENTER

An experimenters' television tube, several special-service tubes, and an A.C.-D.C. beam tube are features this month.

PART III.....R. D. WASHBURNE

THIS MONTH the writer presents a particularly enticing group of tubes, of interest to the experimenter in *radio* (including ultra-shortwaves), *public address*, and *electronics*, ranging from a 3-meter tube delivering better than 500 watts to cathode-ray television receiving tubes or "Kinescopes" that are (states the manufacturer) **BEING MADE AVAILABLE AT THIS TIME FOR THE CONVENIENCE OF EXPERIMENTERS AND AMATEURS WHO WISH TO CONSTRUCT EXPERIMENTAL TELEVISION RECEIVING EQUIPMENT!** Let's give this manufacturer 3 cheers!—and a special vote of thanks!

We will now describe the new tubes in class groups; first on the list is a

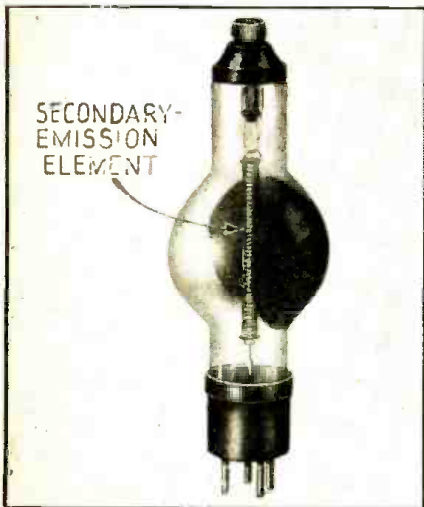

Fig. A. This highly-sensitive "electric eye" utilizes principle of "secondary emission."

photo-cell 4 times more sensitive to light than anything previously available in the commercial field!

PHOTOELECTRIC TUBES

Secondary-Emission Photocell. Employing the principle of secondary-emission (*Radio-Craft*, Jan. 1936), substantially as described last year by Dr. Zworykin in an address before the I.R.E., in the tube shown in Fig. A, it becomes possible to achieve an overall amplification of the voltage generated by impinging light of about 4 times that of the most sensitive, previously-available type (the caesium-on-silver cell which delivers about 70 microamperes per lumen). The new cell has a *primary* emission of only about 40 microamperes/lumen but the *secondary-emission coefficient*, or that amplification which is afforded by the secondary cathode, is about 7.

A supply voltage of 500 to 800 is required for operating the secondary-emission photocell; a safety-resistor value of about 10,000 ohms in series with the supply voltage being recommended. Terminal connections are as follows: only 2 of the 4 base terminal pins are used, namely, anode pin—connects to secondary cathode; grid pin—connects to primary cathode; the cap connection atop the tube connects to the collector anode.

Advantages of the new secondary-emission tube as compared to all existing commercially-available phototubes: frequency-response characteristics and inherent tube noise about equivalent to best available high-vacuum types; sensitivity factor, about 4 times greater.

(Data courtesy *English Mechanics* [Eng.]; tube manufactured by General Electric Co. of Eng.)
(Continued on page 372)

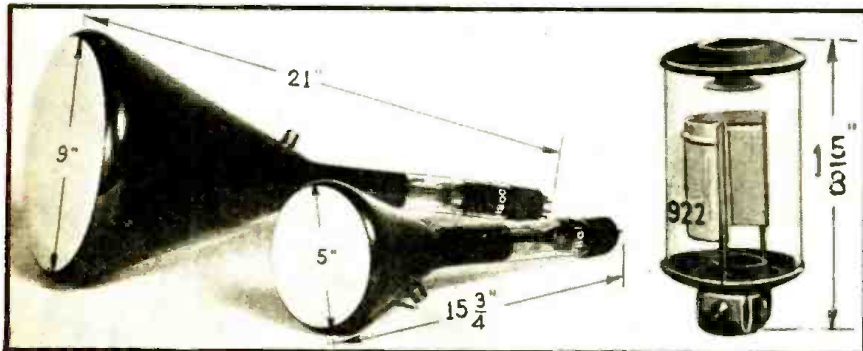

Fig. B. Here is a full-fledged cathode-ray specifically designed for television experimentation! This tube could be worked into the *Radio-Craft* Television Receiver described in the January 1937 and subsequent issues.

Fig. C. This photo-cell features small dimensions.

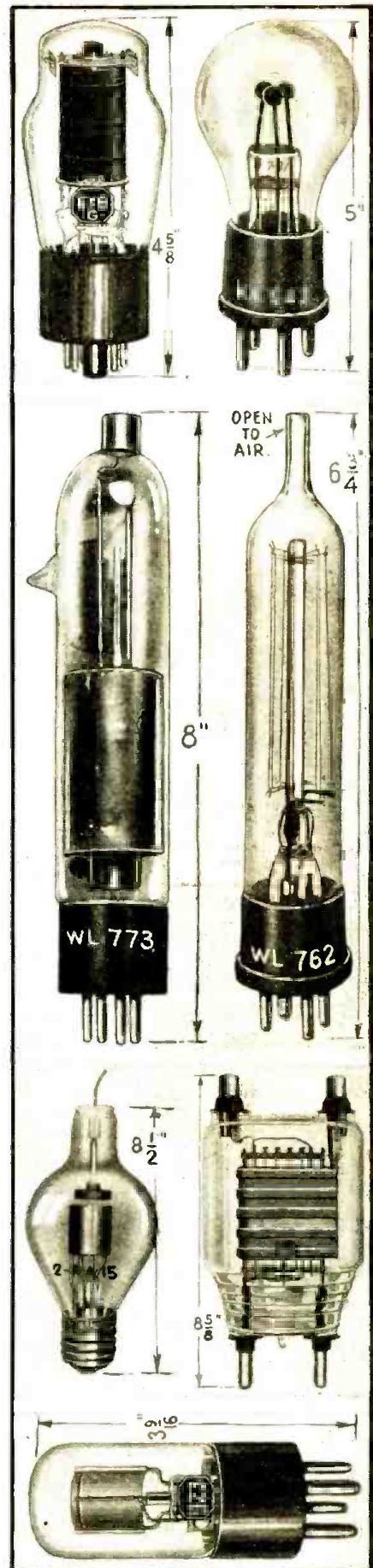

Fig. D. The seven tubes here illustrated include a new ultra-violet sensitive photocell several special-service tubes, and a new, special beam tube for A.C.-D.C. receivers.

SHORT-WAVE RADIO

Radio-Craft brings you probably the first detailed story in any radio magazine, of how Uncle Sam's robot plane made perhaps the world's first entirely automatic landing, as told by Capt's C. J. Crone and G. V. Holloman of the United States Army Air Corps.

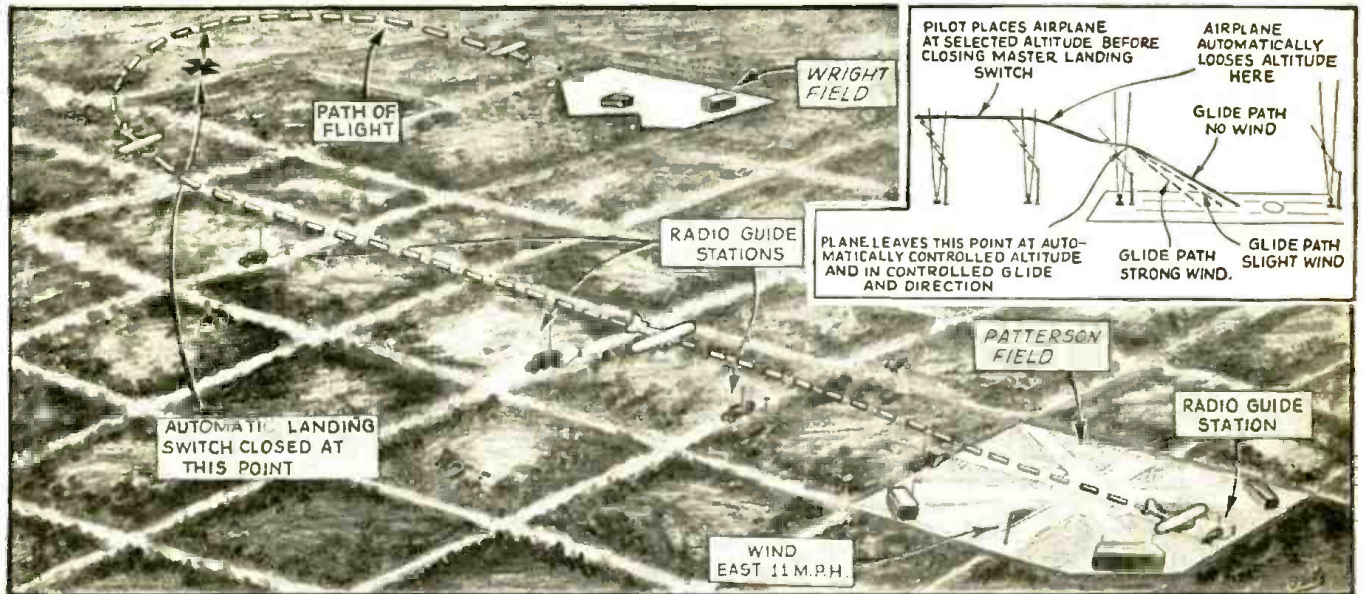

Fig. A. The flight and landing paths of the U.S. Army plane C-14 Cargo as it made the world's first completely automatic airplane landing without a pilot's aid.

MUCH HAS been written in recent months concerning the personal equation during flight and the influence of this equation on accident rates. The newer developments in modern aircraft, to insure high performance, have required an increasing number of cockpit devices, all of which demand the attention of the pilot at some time or other during any given flight.

Pilots have felt and expressed the

need for simplification of the various controls that must be manipulated and have expressed the need for this simplification in no uncertain terms. This simplification means that many of the functions now performed by the pilot in flight control and navigation must be done automatically. The landing of aircraft is no exception to this general trend. With this in mind, the personnel of the Materiel Division, U.S. Army Air Corps, over 2 years ago began active

prosecution of development work to simplify the procedure of instrument landing by making it automatic.

AUTOMATIC FLYING

For over a year Air Corps test airplanes have been flown automatically over distances that have indicated the thorough reliability of the devices employed. This was one step in the perfection of automatic landing. *The features therefore that are built into the automatic landing system are not only useful for the landing but are used throughout the entire flight of the airplane across the radio navigational aids with which the United States is provided.* Test airplanes from Wright Field have been flown automatically from Wright Field as far as Texas, and return, under automatic control. Several flights have also been made from Wright Field via Buffalo, New York, to Newark, New Jersey, and from there via Langley Field, Virginia, to Wright Field, Dayton, Ohio. Of course the automatic landing involves other factors besides control of direction. These factors are: (1) control of altitude, (2) engine control, (3) glide control, and (4) further engine control after landing.

With the provision of the Air Corps automatic landing system in an airplane and with the installation of the new "Z"-type radio range beacons, the airplane may be flown automatically from station to station, from East to West Coast. If we imagine a group of the future "Z"-type radio ranges placed in a line joining the runway of the landing field and extending to a point 5 miles therefrom, some idea will be gained of the essential features of the Air Corps automatic landing system.

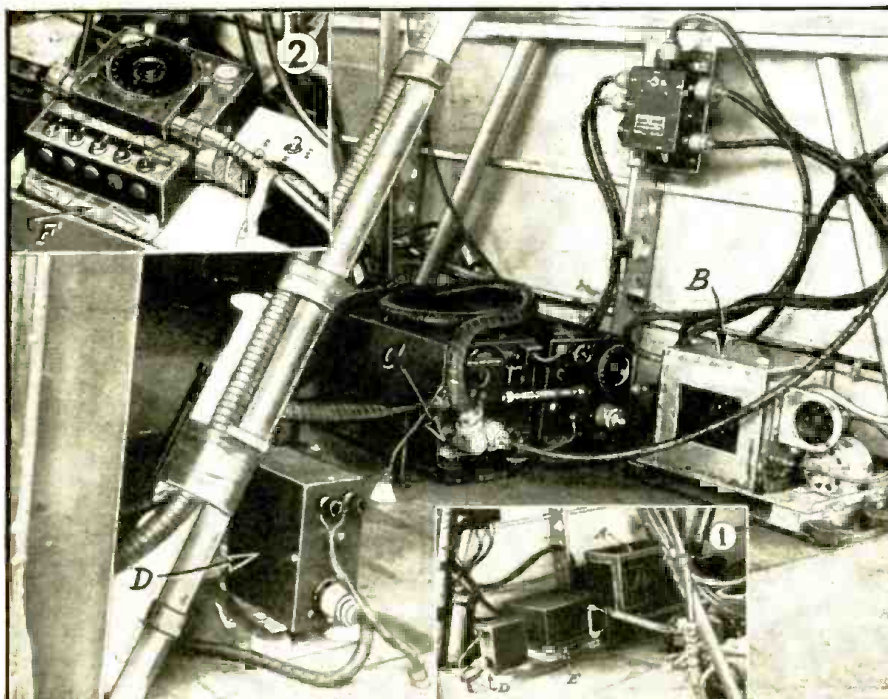

Fig. B. Views inside the cockpit of the Army airplane showing the radio compass and relay; the automatic landing equipment (inset 1), and the frequency selector control box (inset 2).

LANDS ARMY PLANE! WITHOUT HUMAN AID!

AUTOMATIC LANDING

By reference to Fig. A, which represents the path of flight and landing made by the Army C-14 Cargo airplane on Monday, August 23, 1937, a generally clear idea will be obtained of the path of the airplane in the horizontal plane. The insert shows the airplane flight path and landing path which the Army airplane followed in executing what is believed to be *the world's first entirely automatic airplane landing!* This illustration should be self-explanatory and in itself is evidence of the continuation of development on the Air Corps system of instrument landing.

On Monday, August 23, 1937, after over 2 years of intensive research and design with respect to automatic control features and automatic flight procedure, 2 entirely automatic landings were made in the period of an hour under adverse air and wind conditions by Capt. Carl J. Crone, Director of the Instrument and Navigation Laboratory and Capt. George V. Holloman, Ass't Director of the Laboratory and Mr. Raymond K. Stout, project engineer in automatic landing. Since that time additional landings have been made in which disinterested personnel have been carried as observers on the flights in order to check robot landings.

In the execution of an automatic landing, using the *U.S. Air Corps system*, it is necessary for the pilot of the airplane to bring the airplane to a definite altitude, determined by the sensitive *altimeter*, and to place the airplane within the range of radio reception of the ground radio facilities. It is, of course, desirable to place the airplane generally in the direction in which it is expected to land, but this is not necessary as was determined in flight and can be understood by reference to Fig. A in which the airplane was actually placed in a position which headed it 180° away from the direction of final landing! When the pilot has placed the airplane at a selected altitude in the vicinity (20 miles or less) of the landing field, the master landing switch is closed and the airplane proceeds through the following routine in accomplishing the automatic landing:

(a) The selected altitude is automatically maintained and the airplane's heading is changed so that it flies in the direction of the radio guiding station most remotely located from the landing runway.

(b) The new robot landing controls the "take over" as described below.

SEQUENCE OF OPERATIONS

The *altitude control device*, shown at A in insert 1, Fig. B, maintains the proper altitude during the initial approach
(Continued on page 370)



Fig. C. One of 4 mobile "guiding" stations for automatic landings; (1) 1,000-meter radio compass locator antenna, (2) 4-meter marker beacon antenna. Both transmitters operate continuously; the operators in the truck do nothing after starting the L.F. compass guiding station and H.F. marker beacon.

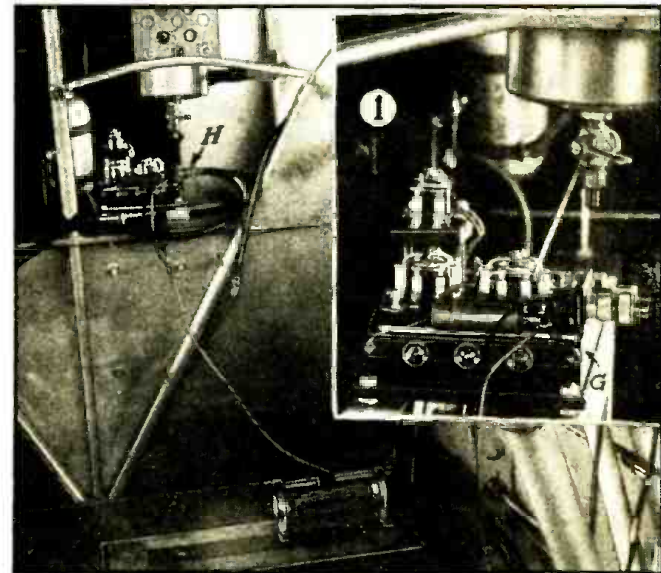

Fig. D. The automatic throttle control used for automatic landings. The inset (1) is a close-up of the control apparatus.

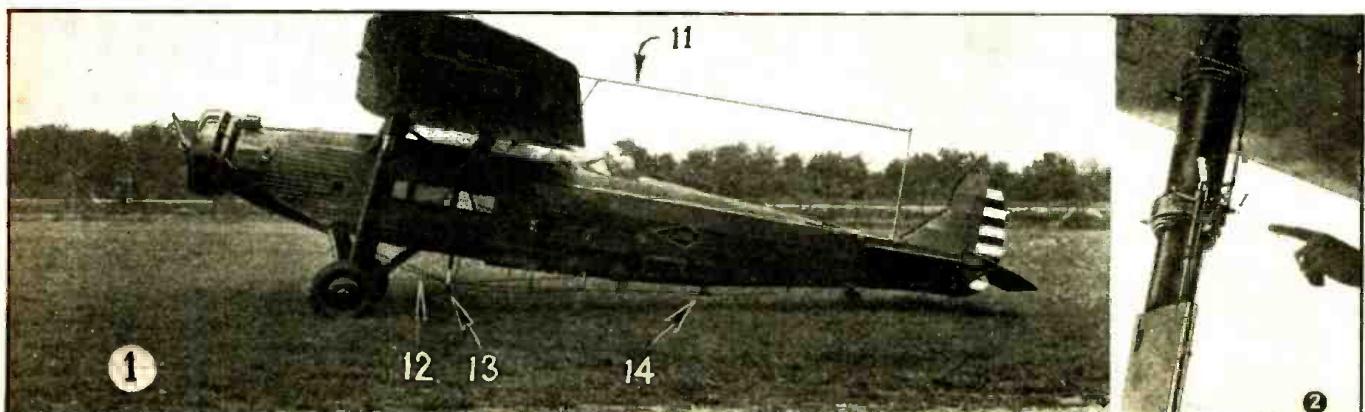

Fig. E. Left, 1—side view of the Army test plane C-14B showing the various antennas used in connection with the automatic landing system; right, 2—a switch on this landing strut of the plane automatically controls the engine-throttling apparatus just as the plane makes contact with the ground.

RADICALLY NEW! "MACHINE-GUN" MIKE "SHOOTS" AMERICAN LEGION PARADE



A Legionnaire ex-machine gunner, from a 6th-floor nest on the Empire State Building, assists WOR's staff "shoot" New York City's day-long American Legion parade. The new W. E. experimental "machine-gun" microphone he's aiming at his buddies can pick up the music of an individual band and follow it up the street!

Radio-Craft presents what is probably the first detailed description of broadcasting's newest, most directional microphone.

M. H. GERNSBACK

ONE OF THE problems which frequently arises in broadcasting events outside the studio is that of picking out voices or music at a distance and suppressing extraneous background noises.

"MACHINE-GUN" MICROPHONE SUPERSEDES PARABOLIC TYPE

The parabolic microphone was developed with this problem in mind. It failed to be completely successful because it is relatively cumbersome to transport and, as shown in Fig. 2C, curve 1, when sharply focused it has a 15 db. rise at 5,000 cycles and thus favors the high frequencies at the expense of the lows. This naturally requires extra equalization equipment. If the focal length is adjusted to flatten out the response the parabolic mike is no longer highly directional as it will cover an area 35° on each side of the center line without attenuation.

In an effort to overcome these shortcomings, Bell Telephone Laboratory has

(Continued on page 366)



New W. E. "machine-gun" mike, at Polo Grounds in N. Y. C., picking up music of a band (not shown in photo) on which it is trained; music of brass band shown above is not heard since only bass notes can be heard off-beam.

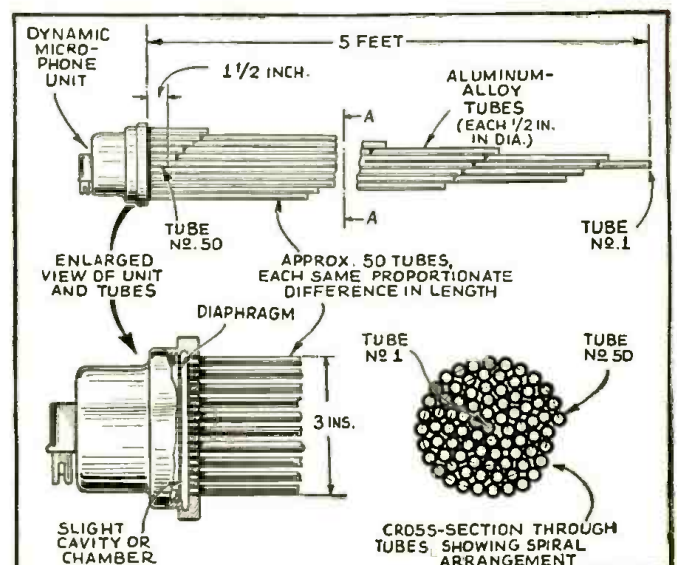

Fig. 1. A bundle of about 50 narrow-bore metal tubes having uniformly different lengths, together with a standard dynamic microphone in front of which they are placed, constitute the new, highly-directional W.E. experimental mike.

"ELECTRIC EYE" PROTECTS WILD GAME

The manner in which a "robot guard" shoos away only animals, at the gate to a German game preserve, makes an interesting explanation not contained in previously-published descriptions of this system.

AN ELECTRONIC "robot guard," that operates without a human person being within miles of it, has been successfully used at a German hunting preserve to prevent wild game leaving the grounds; motor vehicles however do not actuate the device!

This preserve is located some 50 miles from Berlin and for reasons best known to the City Planning engineers was transected by several highways. Although the entire preserve was fenced-in, the animals very often strayed through the gates at each highway entrance and exit, and were lost to the county since residents insisted upon "taking care of them."

OLD TURNSTILE USED MAN-POWER

To prevent these losses the authorities first placed across each highway entrance and exit a huge turnstile constructed of wooden logs. These turnstiles were constructed in the manner of a ferris wheel with the logs running horizontally across the highway. It was necessary for an automobile driver to stop, pull up the log which was impeding his passage and then pull down the succeeding log in order to block the highway once more. Aside from the fact that very often drivers "forgot" to block the highway this system was necessarily a slow one which considerably impeded the flow of traffic.

After many lengthy experiments the system to be described was installed and is now operating successfully.

INITIAL ELECTRONIC GUARD

At each entrance and exit to the game preserve an extended arch made of logs is constructed. Across the inside end of these arches (facing towards the preserve) is arranged a light beam as indicated in photos A and B, and the sketch, Fig. 1.

In order to leave the preserve, animals must pass under these arches and, in doing so, interrupt the beam of light; whereby, after a predetermined number of seconds has elapsed (at which time the animal would be inside the arch) 2 glaring floodlights flash on brilliantly, illuminating the interior of the arch and at the same time a loud-sounding, automobile-type horn commences to function. The animal is scared back into the preserve and hence is not "lost."

The only drawback to this system was that automobile drivers (and motorcyclists) before passing through the arch (and interrupting the beam of light), had to stop, press a button on a post underneath the sign shown in Fig. A, and then proceed to pass through in order not to set off the alarm. (Pressing this button reverses the operation of the PE. cell circuit so that the apparatus is not caused to function even though the light beam is interrupted. See schematic, Fig. 2.)

This, of course, was a nuisance and in most cases not complied-with by drivers, the result being that each time a car passed the scare system would go off, gradually "acclimating" the animals to this reaction. After a while it did not scare them back into the preserve.

(Continued on page 368)



Fig. A. The animal in the above photo has just interrupted the light beam and is startled by the sudden glare of 2 floodlights and the blaring of an automobile-type horn! In a flash he will be scared back into the preserve ground.



Fig. B. This is an interior view of one of the arches looking toward the preserve grounds. Notice how the exciter-lamp housing is placed to throw the beam of light across the entrance. The insert is a close-up view of the exciter lamp housing. Motor vehicles do not actuate this "robot guard"; only animals "touch it off."

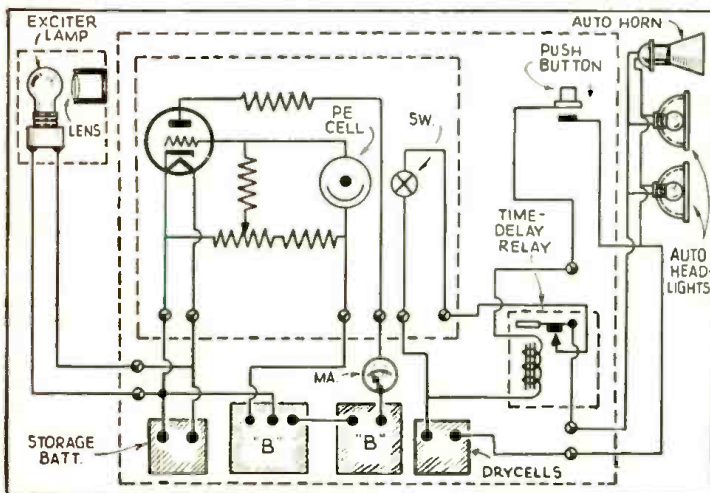

Fig. 2. Schematic diagram of the "electric eye" system used to prevent straying of wild game. The entire circuit is powered by batteries.

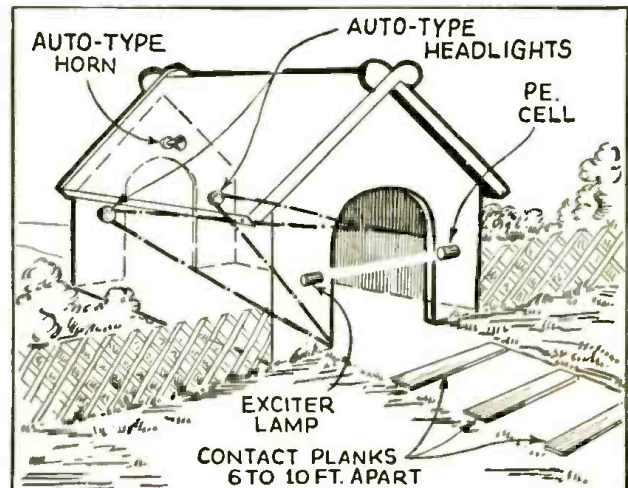

Fig. 1. Artist's sketch showing the complete system and the layout of all components. The view is looking outward from the preserve grounds.

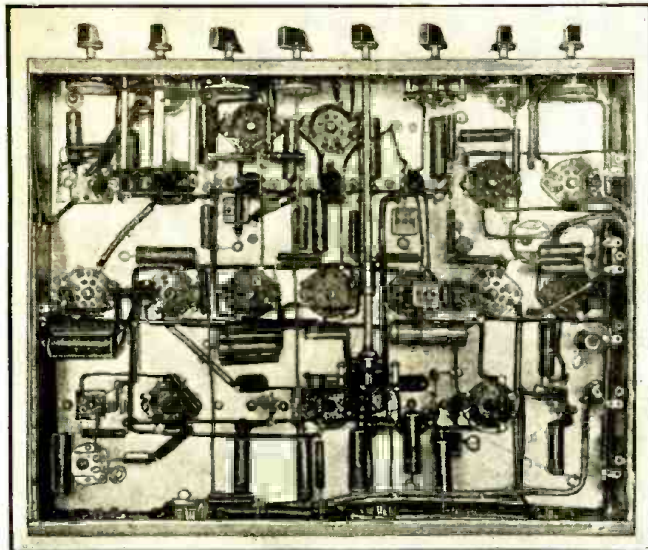

Fig. H. Under-side view of Chassis No. 2 showing arrangement of wiring.

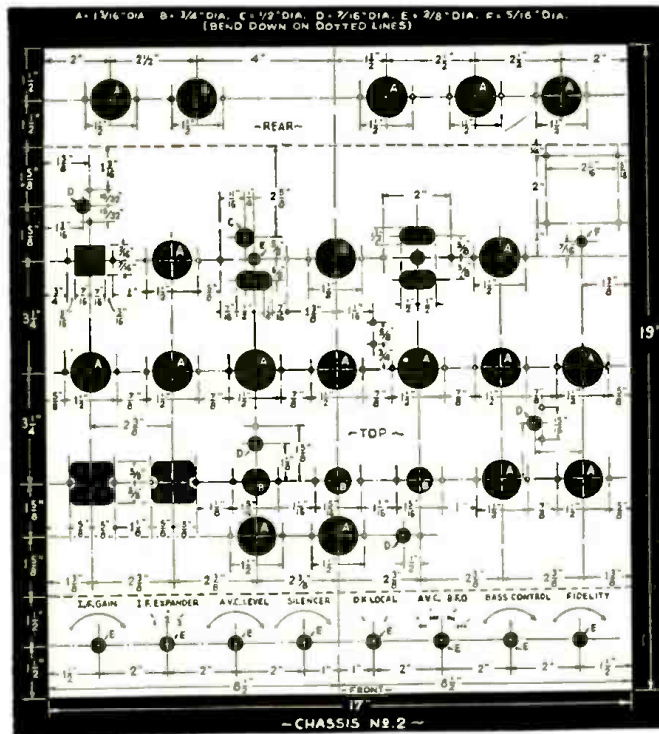

Fig. 7. Complete physical specifications for making the base of Chassis No. 2.

HOW TO MAKE THE RADIO-CRAFT SUPER-DELUXE 30-TUBE SET

Concluding half of the chapter on the I.F. Channel and Automatic Control Circuits.

PART IIIB

IN CONCLUDING this chapter, the first portion of which together with the complete List of Parts appeared last month, we take up the details of building Chassis No. 2. The chassis should be carefully marked off, according to Fig. 7, and all holes drilled. Do not mount any parts permanently until the chassis is completely drilled. The 14 octal sockets must be mounted as shown in Fig. 6 (Part IIIA). The keyways must face in the proper direction so that all plate leads will be short and direct. Also place a lug under each socket as shown. When this has been done, mount the balance of parts as shown on the parts layout, except the band-expanding switch. This switch is mounted after the wires leading to I.F.T. 1 and 2 are in place.

THE 15 STEPS TO COMPLETION OF CHASSIS No. 2

- In order to do a neat wiring job, the following sequence should be carried out:
 - (1) Connect to a grounded lug, the shell prong and also the cathode prong, on those sockets which carry a tube with the cathode grounded.
 - (2) Wire up each remaining heater prong in the 3 groups shown in Fig. 10.
 - (3) Connect plate leads to all sockets except V18, V19 and V21. These are wired later on.
 - (4) Connect all "B" plus leads to terminal connections.
 - (5) Connect all screen leads.
 - (6) Connect all remaining cathodes.
 - (7) Connect all grid returns.
 - (8) Wire up the variable controls and switches as shown in Fig. 11 and Fig. 12, sections A, B and C.
 - (9) Connect up all remaining loose ends.
 - (10) The sockets mounted on the rear chassis apron should be marked off *first* (see Fig. 8) before wiring and then wired accordingly. This is necessary because of the previous wiring done to the plug cables on Chassis No. 1.

(Continued on page 367)

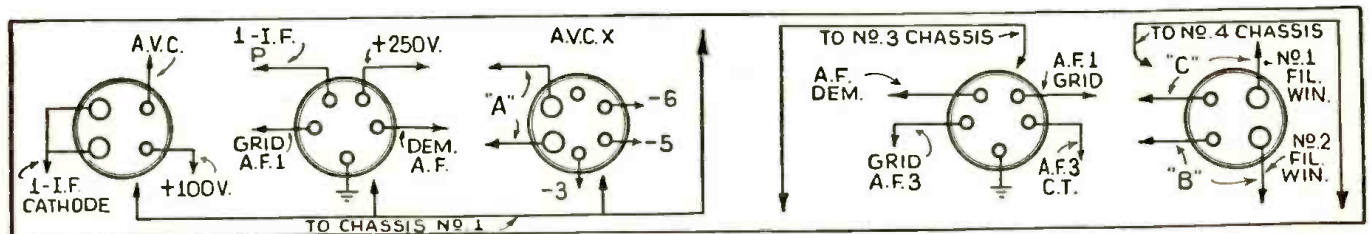

Fig. 8. Markings on the sockets on the rear apron of the chassis.



Fig. 9. Markings for the various controls on front apron of the chassis.

TELEVISION STUDENTS LEARN BY MAKING CATHODE-RAY TUBES

This description of steps in making a practical television receiving tube experimentally in a school laboratory is believed to be the first newsstand-magazine disclosure.



Fig. C. A blowtorch helps fuse screen to slowly-revolving television-tube envelope; while gas flames from all sides maintain glass at even heat. It is this operation which the cover painting depicts in colors.



Fig. D. With screen fused-in, tube is cooled by slowly reducing flames.

U. A. SANABRIA PART II

A BLOWTORCH plays a red-hot flame on the end of a slowly-rotating glass tube—the glass slowly softens—soon a glazed porcelain appearance is obtained and, presto!, the step is finished! A television cathode-ray tube has taken a second step toward completion!

Last month we told you what materials to use for the screen, how the screen fluoresces, how the tube "blank" was obtained, and the preparations necessary prior to the operation, next to be described, of fusing the screen.

FUSING THE SCREEN

We found it best to put the flask on a horizontal rotating machine and apply to it a large blowtorch of the oxy-acetylene type but employing ordinary illuminating gas and oxygen (in order to obtain a large, low-temperature flame), so as to heat the glass to the softening temperature. See Fig. C.

This method worked very well and permitted the glass to get soft while spinning. This allowed the glass to maintain its shape and still become warm enough to be soft and yet not sag. If however the glass was heated too hot so as to melt, it would run and spin away from the center toward the outside and spoil the flask by making it too thin; while at the same time cracking the screen and leaving large streaks.

It was therefore necessary to apply exactly the right amount of heat and spin the bulb slowly.

We were then able to prolong the heating to several minutes. We soon found that it was best to apply a very slight air pressure inside of the spinning vessel through a rubber tube connected to the operator's mouth to press the crust of screen material against the soft glass at the end of the bulb with a gentle enough pressure to make a just-visible distortion and rounding-out of the glass.

After the screen was completely fused with glass, the temperature was gradually reduced over a period of several minutes while the bulb was spinning. This was to allow the partially-soft glass to gradually readjust itself to any new distortions so that, upon complete cooling, all bulb strains would be removed. See Fig. D.

You can readily appreciate that if one part cools and contracts and another part on the opposite side cools and contracts, that a strain will exist between the two parts tending to pull the glass between them toward each other. If this glass is heated warm enough to be bend-

(Continued on page 368)

Mr. Winner describes the newest application of acoustic principles discussed in past issues of *Radio-Craft*.

NEW CONSOLE UTILIZES "BASS REFLEX"

LEWIS WINNER

THE PROFESSIONAL PERFORMANCE provided by the popular "Super-Pro" (heretofore available only in the table model or rack-and-panel style), plus a wide-range reproducer system, may be enjoyed by those at home.

The console has remarkable acoustical proper-

ties—a most essential feature required to match the other professional features of the receiver. To achieve this exceptional acoustic performance, the new Bass Reflex system has been incorporated in the console in association with a special 15-in. loudspeaker.

PROBLEM: "NON-CONTROLLED REAR RADIATION"

It is well known that many in the present run of radio cabinets have recognized disadvantages.

(Continued on page 363)

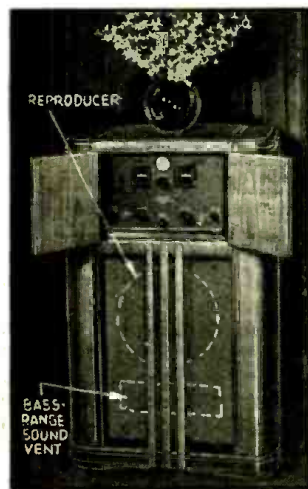

Front and rear views of the newest "bass reflex" console cabinet.

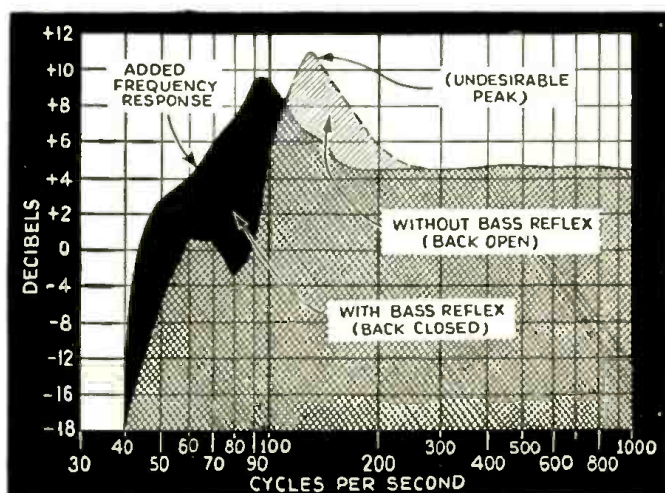

Closing the back, and opening front pressure-release vent, improves bass.



Fig. A. This tiny bedside quiet set is so attractive, even Scottie has taken a fancy to it. Note high-fidelity crystal earphone; and absence of dials.

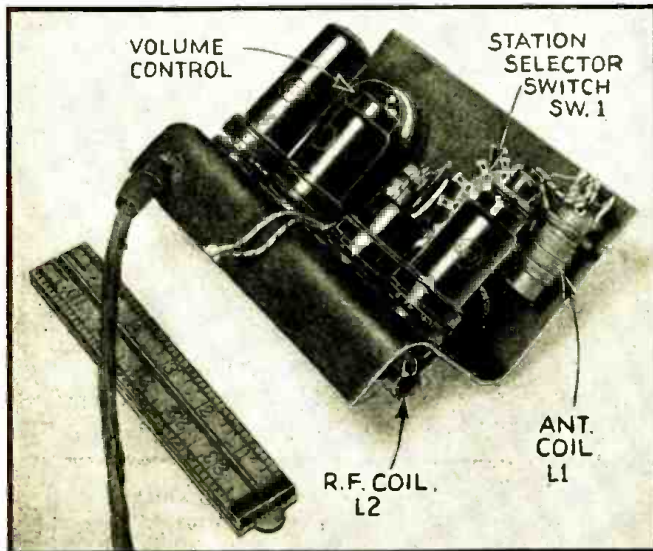

Fig. B. The 10 tuning condensers, added later, for the sake of clarity do not appear in this photo. Note ruler, left, shown for size comparison.

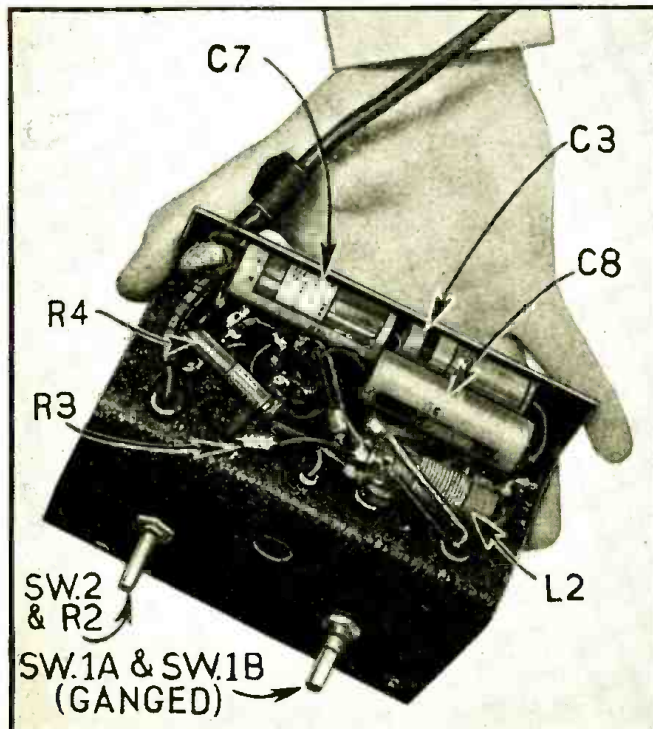

Fig. C. Installing R.F. coil L2 underneath the (almost Z-shaped) chassis automatically shields this portion of the circuit from that of antenna coil L1.

BEGINNERS!—BUILD THIS "TINY TIM" 4-TUBE SET

The "bedside quiet set" here described in great detail has utility not only for the sick-room but also as a traveling companion; and as an auxiliary, "personal" set.

RAYMOND P. ADAMS

THERE ARE TIMES—plenty of them—in the listening life of Mr. Average Radio Fan when he'd like to intercept some local, "wee hours of the morning" program but simply doesn't because the better-half won't let him. What is needed is a "personal set."

WHY A "PERSONAL SET"?

Speaker reproduction *will* keep folks awake, it seems, even when adjusted for minimum level consistent with good audibility. There are other times when there's something of particular interest which he personally wants to hear—but right at the same hour when little Bobby gives ear to the exciting adventures of Mike O'Malley Among the Indians or when the older youngsters dial the blaring brasses of Sally Swing and her Sister Syncopatens—or when for one reason or another, every individual in the house but himself is adamant in his or her demand for absolute quiet. There are times when he'd even like to go to sleep with the restful notes of the Midnight Organist impinging upon *his* exclusive ear—but hasn't a chance in the world unless some happy bachelorhood affords him a wide world of a room all to himself.

A second receiver in bedroom, den, or workshop—perhaps a now familiar midget-type set with limited speaker output—sometimes fills the breach pretty well and makes everybody more or less happy. But not always. Actually, there's very little opportunity here for one individual to listen whenever and for as long as he wishes—without disturbing someone, somehow, sometime.

But if all this suggests a rather difficult problem—or a seemingly difficult problem—we ought to be set at rights without delay. For the simple, and one and only answer is a "quiet-set"—extremely small and compact, extraordinarily inexpensive, limited in range to a local metropolitan area and in selection to 4 or 5 important network stations, affording *perfect* fidelity of reproduction, and feeding into a handle-type earphone with sufficient volume to give signal audibility with the phone unit under a pillow or resting on the arm of a chair. Such a set would cost but a few dollars to build, recommend itself for duplication and use in several rooms in the house (or office), and afford truly "personalized" reception to each and every individual.

THE TINY TIM "QUIET SET"

The Tiny Tim "quiet set," here illustrated and described, perfectly meets the above requirements. It is small and portable, to begin with—the cabinet being about 6½ ins. long, 5½ ins. high, and 3½ ins. deep. It has a volume control and a signal selector control, is A.C.-D.C. powered, uses 4 tubes (including rectifier), employs a self-contained antenna, and feeds a high-fidelity crystal-type earphone.

Reproduction is of highest quality (the crystal phone is considered a component part, noticeably contributing to such reproduction); power output is ample for clear audibility of all signals; selectivity is quite sufficient to prevent "monkey chatter"; and sensitivity is high enough to permit DX reception if it is desired. The circuit has been worked out to afford all these characteristics with use of a minimum number of inexpensive parts, and no changes in

LIST OF PARTS

- One Meissner antenna coil, less shield can, No. 2436, L1;
 - One Meissner R.F. coil, less shield can, No. 2437, L2;
 - One Meissner 2-pole, 5-position shorting selector switch, No. 18253, Sw.1 (A&B);
 - Ten Meissner trimmers, No. 14061-4 7-80 mmf. each, condensers Cx;
 - *One potentiometer, with switch Sw.2, No. 203, 0.5-meg., R2;
 - *One resistor, with adjustable tap, 10 W., 5,000 ohms, R4;
 - One Continental Carbon resistor, type M-5, 300 ohms, 1/2-W., R1;
 - One Continental Carbon resistor, type M5, 50,000 ohms, 1/2-W., R3;
 - One line cord for A.C.-D.C. sets, 250 ohms, R5;
 - Two Aerovox condensers, type 261, 0.1-mf., C2, C3;
 - One Aerovox condenser, type 248, 0.002-mf., C1;
 - Two Aerovox condensers, type 284, 0.25-mf., C5, C6;
 - Two Cornell-Dubilier electrolytic condensers, 4 mf., C7, C8;
 - One Aerovox mica condenser, type 1468, 50 mmf., C4;
 - One Brush earphone, type A (lorgnette);
 - Ten ft. No. 24 D.C.C. wire; *Two clips;
 - *Ten ft. No. 18 push-back wire;
 - Two fuses, 1 A., and fuse blocks (optional);
 - One 2-point tie assembly;
 - Five grommets (3, 3/8-in., and 2, 1/2-in.);
 - *Four sockets with retainer rings;
 - One National Union type 6K7 tube, V1;
 - One National Union type 6H6 tube, V2;
 - One National Union type 6C5 tube, V3;
 - One National Union type 25Z6 tube, V4;
 - One chassis and panel piece, 6 x 7 3/4 ins.;
 - Two brown knobs, pointer type;
 - One bronze 5-point plate marked SELECTOR;
 - One bronze plate, to match, marked VOLUME.
- *Names of manufacturers will be supplied upon receipt of a stamped and self-addressed envelope.

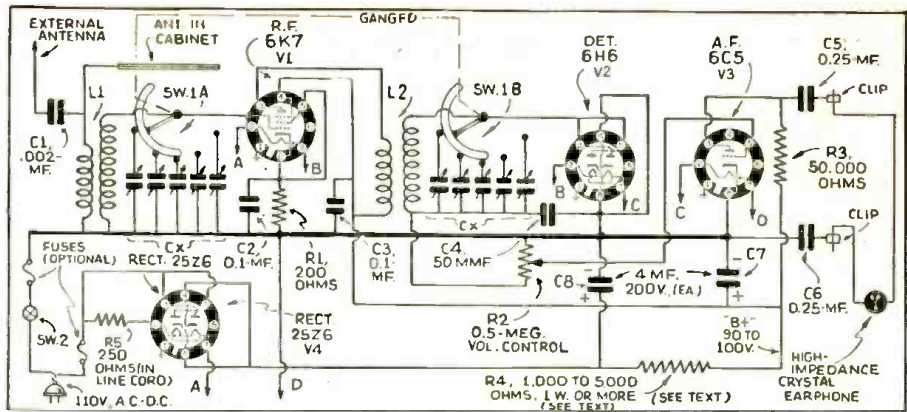

Fig. 1. Schematic circuit of the complete, selectively-tuned receiver. It is duplicated pictorially in Fig. 2.

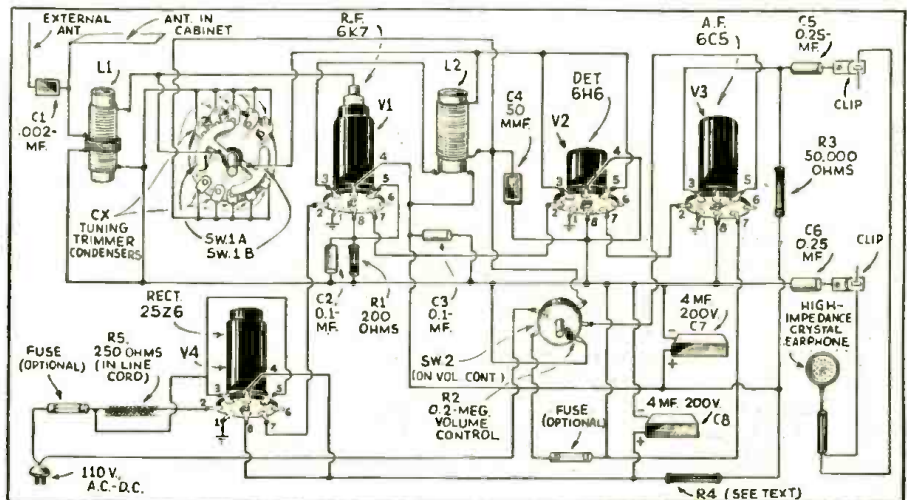

Fig. 2. Pictorial diagram of the "Tiny Tim" for those who find schematics a bit too much to tackle.

values or make of components should be made if proper performance is to be expected.

THE CIRCUIT

An R.F. tuned stage is employed, with self-bias, for maximum gain and ample R.F. preselection. (Selectivity is a function of gain and tuned-circuit characteristics; and although a variable cathode resistor [acting as a volume control] would permit a variation of conductance and prevent cross-talk such a refinement seems hardly desirable, as it involves use of an additional control and some increased cost of construction.)

Unit L2, fed by the 6K7 R.F. tube (the screen-grid voltage of which is secured directly from "B plus") is, like L1, an unshielded midget R.F. transformer to be tuned to signal frequency. The detector is a 6H6 with plates and cathodes paralleled. Mica condenser C4, of 50 mmf. capacity, is the R.F. bypass unit—small enough to prevent attenuation of the higher audio frequencies and large enough to com-

pletely exclude all trace of R.F. from R2, which is the audio load resistor for the diode (and, of course, the variable volume control for determining A.F. level). An A.V.C. circuit might have been used but is not included in the design for reasons of simplicity; the set is intended, primarily, for hi-fi local reception.

The audio tube—a 6C5—is diode biased, and no coupling condenser and grid resistor are required. Actually, both the audio frequency and rectified D.C. components of the signal are fed through to the V3 control-grid. The control-grid is therefore biased by the amount of voltage available at the center arm of potentiometer R2. Inasmuch as detection is linear, this negative D.C. will be related to the carrier of the signal only and will not be affected by modulation, so that for a given signal of certain level, V3 bias, potentiometer selected simultaneously with A.F. level, will be constant. In other words there is no change in V3 bias except with (a) a change in position of the center arm of

(Continued on page 360)

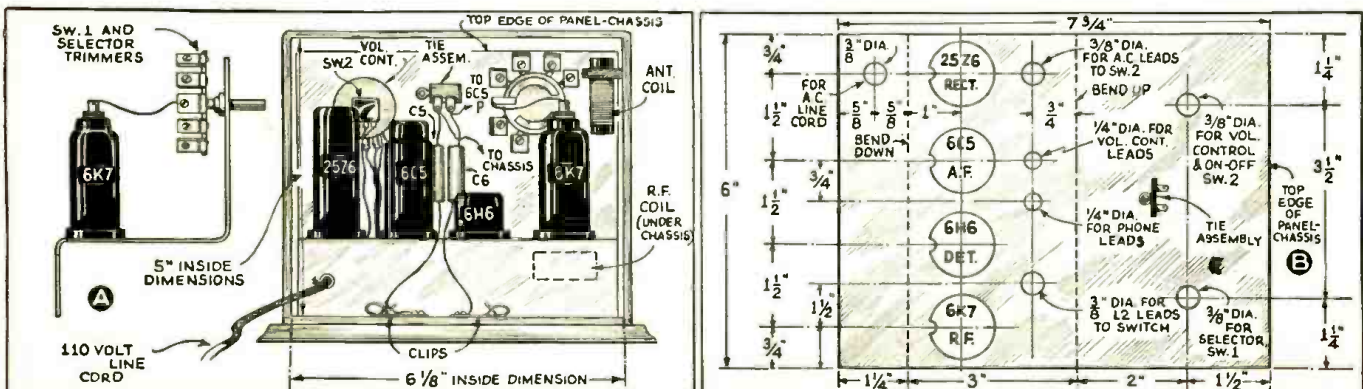

Fig. 3. A, showing the placement of parts and the method of mounting the tuning-trimming condensers on the rotary, station-selecting switch; and B, complete physical specifications for making the chassis.

FUN WITH RADIO PARTS

WALTER



(Photo—Radolek Co.)

Fig. A. The Radio Witch.

THE LIFE of the party," is what they will call the radio experimenter who exhibits a little ingenuity in applying to amusement purposes some of the simplest of radio principles, when next he entertains his friends.

The fun may extend from a simple foursome of personal friends to an extensive party perhaps having a holiday tie-in.

Augustina Zilch shown in Fig. A, for example, once furnished no end of hilarity for a group of Hallowe'en merrymakers composed of some well-known Chicago radio and advertising people. Augustina, the combination ghost and witch who formed a committee of one to welcome the arriving guests at this particular party, comprised certain wood fittings, a bed-sheet and a loudspeaker and audio amplifier. Groans and sepulchral greetings enough to turn the hair of any ordinary person set the guests in the proper Hallowe'en mood for the evening. Ghost-witch Zilch was placed at the entrance gate and certain members of the party located in the house gave voice to this "spirit of Hallowe'en" by remote control merely by speaking into

a microphone connected to the amplifier.

You may wish to apply this idea to a "post-Hallowe'en" party. The possibilities of providing many unusual effects for parties of this kind are limited only by the ingenuity of host and hostess. For instance you might use an electric phonograph to reproduce a previously-recorded program of blood-curdling sound effects, in place of having hidden conspirators talking into a remote microphone; and in lieu of an effigy of sorcery an illuminated, hollowed-out pumpkin may be used to house the loudspeaker. With something of this sort as a starting point the manner of continuing the bedevilment throughout the evening becomes quite easy.

"RADIO" DECORATIONS

It might be well to give your next house-party a more nearly "radio" atmosphere, right at the start, by using radio parts for decorations as well as entertainment. A little thought on this subject will show just how attractive and inexpensive such party decorations can be made.

For instance, I know of one radio fan who is quite successful at fashioning animals—dogs, cats, giraffes, etc.—from lengths of stiff wire. The colored hook-up wires are particularly attractive for this purpose. The wires are twisted and formed into grotesque forms which resemble (it is hoped) the animal represented. The tails are formed by untwisting the insulation and cutting off the inside wire.

One radio fan, with an artistic bent, has made some fine caricatures of famous people using radio parts for the features and outlines. These caricatures are made on wooden panels which may be hung on the walls as decora-

tions. Such parts as dials, binding posts, pilot lights, hook-up wire, etc., are used in the makeup of these amusing ornaments. "Goofey Gus," shown in Fig. B, is one example of a radio ornament that never fails to get a laugh.

Other interesting ornaments made from radio parts, which I have seen, include many items that also have considerable utility. For instance, ash trays may be cut from transformer cans; table lamps from transformers, coils, tubes and other parts; etc.

RADIO CHECKERS AND CHESS

If the group you plan to get together is sufficiently technical-minded you can spring on them the novelty of a "radio checkerboard" made as shown in Fig. 1. All you need is a piece of board and some way to mount it at the proper height for playing the game; and a set of 24 discarded tubes. If you haven't enough tubes handy the local radio repair shop probably will bless you for taking a quantity of them off its hands. To provide the "radio checkerboard" thus costs you no more than the time it takes you to get the above items together and to drill the proper number of prong holes in the board. The game is ready after you've lacquered the tubes on top; red for one player and black for the other.

The same idea may be extended to chess by lettering the tops of the tubes to represent the chessmen (K, king; Q, queen; R, rook, etc.).

At some more ambitious parties a "radio mind-reading act" has been put on with great success. Whether you feel like tackling the idea depends mainly upon your ability to build a very small short-wave sending and receiving set. In any event, you'd need a transmitting license to operate the equipment; or you could get a licensed amateur to

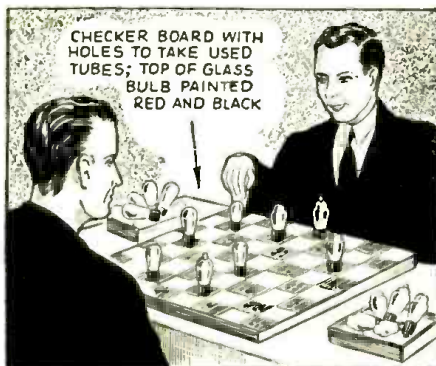

Fig. 1. Tube "men" plug into board. (G.E. Co. once suggested game with "metal" vs. "glass.")

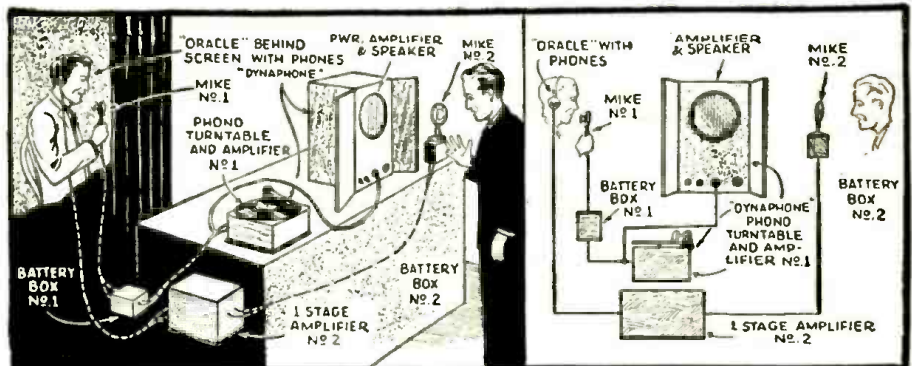

Fig. 3. The "Radio Oracle" apparently answers your question straight from a phonograph. That is, provided you don't know the "secret," a concealed confederate, as shown above!

Once you get started it's easy to make a "radio party." A number of clever ideas are described in this article. They range from decorations having a "radio" angle to a regular entertainment program for a house-party. Look these over and let us know whether you can add to the list.

PALMER

operate it for you. The general idea, illustrated in Fig. 2, is outlined as follows:

MIND-READING ACT—RADIO SYSTEM

A tiny radio transmitter made in the form of a belt worn by the "man" in the act is concealed in his clothing as he wanders about through the audience asking questions which his girl companion (blindfolded and seated at one end of the room or on the stage) answers, concerning the members of the audience. A tiny fixed-tuned receiver concealed in the girl's clothing or in the chair on which she sits provides the necessary communication to enable the acts of so-called mind reading to be performed. An inconspicuous phone unit of the type used for deaf-aids is carefully inserted in her ear with the wire slipped under her hair and down to the receiver. The actual details of transmitter and receiver may be determined experimentally by the radio man. The small "acorn" tubes or, better yet, the tiny English tubes described in past issues of *Radio-Craft* lend themselves admirably to this purpose both as transmitters and receivers. This is the "radio" method of putting on a radio mind-reading "act."

MIND-READING ACT—AUDIO SYSTEM

A simpler method, and one which has worked out admirably in practice, is the "audio" method; one version of it, worked up by *Radio-Craft* for the Radio Show in 1935, utilizes a specially-recorded phonograph record, 2 microphones, and a power amplifier and loudspeaker, as shown in Fig. 3. Visitors to the Show will recall this as the "Radio Oracle" that answered any and all questions—and how!

The "—and how!" is where the fun comes in. A confederate concealed in a place where he (or she) can watch without being seen is equipped with headphones and a microphone. The "master of ceremonies" or interlocutor, acts as the go-between for inquiring guests and the "Radio Oracle." The "m.c." arranges the guests in a row and takes them as they come, one question per guest. The trick is to make the whole operation appear on the surface to be a full-fledged "radio" act; and to ask leading questions that the person acting as "Oracle" can turn into a laugh-provoking situation by a clever remark perhaps based on the question or on his knowledge of the person asking the question; that's where the "seeing without being seen" part comes in.

We've kept you in suspense, but here's how the phono record works in. On it is recorded, say, 3 slow "bongs" of a big dinner gong, a snatch of music, a fade-in of a



Fig. 8. Goofy Gus. You make him out of wire and a telegraph-key knob.

deep, sepulchral voice slowly intoning, "T-h-e R-a-d-i-o O-r-a-c-l-e S-p-e-a-k-s," a fade-out of the voice, and then the "oracle" comes in with the answer. Each time a question is asked the master of ceremonies must pick up the tone arm and put it on the phono record again, and repeat the playing of the introduction—the pickup is then left on the record and the record allowed to turn, until the question has been answered; whereupon the pickup must be immediately removed or the turntable stopped.

The illusion thus created in the minds of most non-technical persons—and even some radio men!—is that the "answer" is recorded on the record and that the correct answer is being picked up from the record by some sort of mystical hocus-pocus that is not quite clear. If properly done the illusion is very effective. Any of your friends owning a radio set equipped with a home-recording attachment will be glad to help you make the "key" record.

Yes, indeed, a radio experimenter with a sense of humor and a few radio items can have no end of fun working up a "radio party."

THE MOCK "BROADCAST"

You can close the evening with a "mock broadcast" that will have them guessing for quite some time. Here's how you do it.

Connect a microphone into the audio section of your radio set as shown in Fig. 4A, then "fade" from a hot dance orchestra to your microphone and put "on the air" some special announcement of a humorous nature directed at one of the guests.

Some people who have worked this stunt prefer to do it this way. (You don't need the potentiometer, for fading, shown in Fig. 4A.) Just wait until the music has ceased and the station announcer is just about due to come in with his

(Continued on page 361)

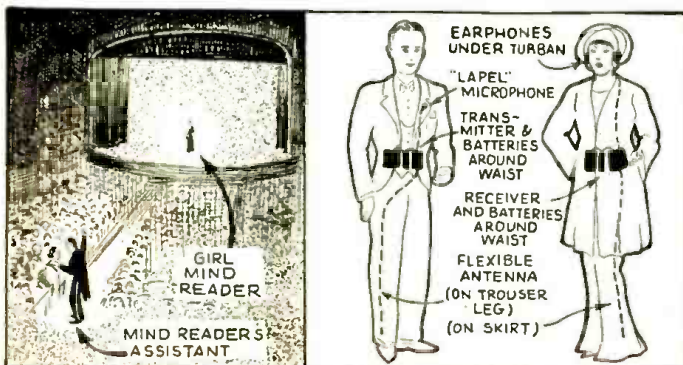

Fig. 2. A short-wave set helps along a "mind-reading" (?) act.

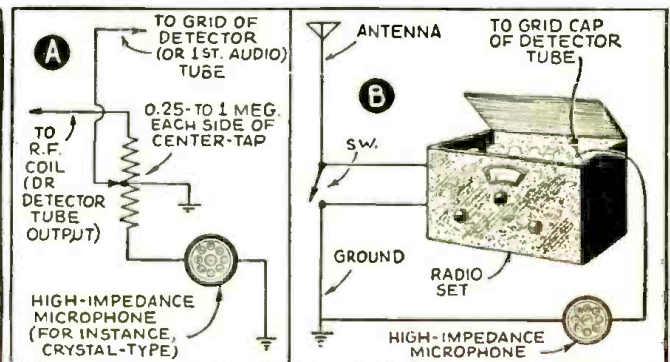

Fig. 4. Kidding the kidders—with a mock broadcast!

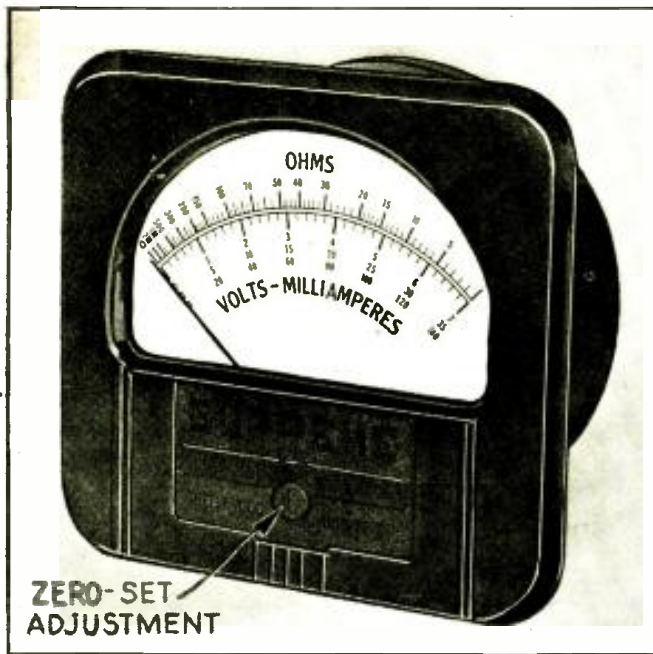

Fig. A. The scales on a typical modern multi-range meter. Note the various scales for the different ranges as well as the tapered knife-edge pointer.

WHAT HAS BEEN SAID up to this point should convince any Service Man that, if he is to make his electrical tests with any degree of accuracy he must:

- (1) Use high-grade meters of reliable manufacture, and which have high inherent accuracy.
- (2) Handle and use these meters with care, so that they will maintain their initial high accuracy over a long period of time.
- (3) Give due consideration to all inaccuracies which may occur due to the particular way an instrument is being used or the conditions under which a measurement is being made.
- (4) Take all readings carefully so as to reduce observational errors to a minimum.

Remember that if maximum accuracy and utility is to be obtained from an instrument, all of these precautions must be observed. Since inaccuracies due to items 2, 3 and 4, are really more dependent upon the Service Man himself than they are upon the instrument, and are more or less under his own personal control, we will leave them at this point. What has already been said about them should be sufficient to make their importance clear.

Let us now return to the subject of *inherent* meter accuracy (or inaccuracy). That is something that comes with the meter when the Service Man buys it—something he cannot readily change or correct. Let us see (a) just how large the errors usually are in high-grade commercial servicing instruments, (b) where they occur on the scale, (c) how they are expressed, and (d) how (if at all) they affect service work. This takes us into the subject of *inherent meter accuracy* (or inaccuracy), a subject which has long been confusing to the servicing fraternity in general. We will try to explain

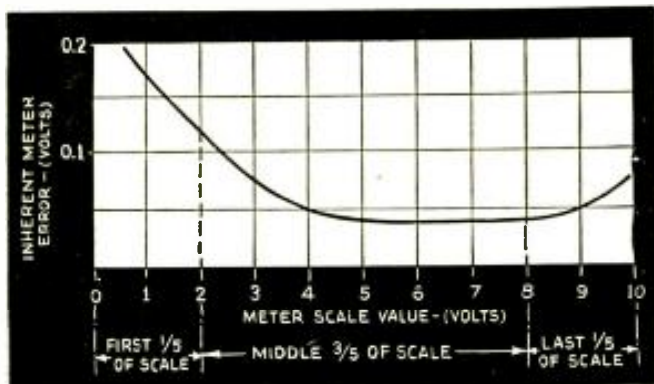

Fig. 4. Graph showing the actual inherent errors which were found to exist at all parts of the 10-V. scale of a commercial D.C. voltmeter.

HOW DEPENDABLE ARE YOUR METER READINGS?

Mr. Service Man: nowhere in the entire field of radio literature will you find anything like this article! It contains previously unpublished, down-to-the-ground facts you need.

ALFRED A. GHIRARDI, PART III

it in a manner that will clarify those points which have caused difficulty.

HOW ACCURATE NEED METERS BE FOR RADIO SERVICE WORK?

Before considering the actual accuracy of commercial servicing instruments, let us see how accurate a meter really needs to be for ordinary service work. Most commercial radio sets are constructed with *potential, current and resistance tolerances* of 10% or more. It is generally conceded that meters whose inherent accuracy is within 2% of full-scale value are satisfactory for servicing use. Most high-grade commercial servicing instruments afford this degree of accuracy, provided they are in good condition. Of course, for special work, where laboratory precision is required, it is important that much more expensive and precise meters be employed.

ON WHAT PORTION OF A METER RANGE CAN THE MOST ACCURATE READINGS BE OBTAINED?

It is practically impossible to build medium-price meters on a production basis with hairline accuracy over the entire meter scale. Because of bearing friction, the initial "starting torque" necessary to get the movable coil and pointer moving, and also because in the "at rest" position the movable coil is almost out of the field of the permanent magnet, the error in permanent-magnet movable-coil type instruments usually runs rather high on about the 1st 1/5 of the scale. From there, up to around 4/5 of the scale, the accuracy is much better.

Since most medium-price meters are calibrated around the 4/5 full-scale point, the accuracy is almost "on the head" at this region. Above the 4/5 region, the inaccuracy usually *increases* again, but is not usually as bad as at the lower end of the scale. In general, on multi-range instruments, the accuracy on the last 1/5 of the scale is about as good as the accuracy of the 3rd 1/5. Therefore, insofar as the meter itself is concerned, it usually has its greatest *inherent errors* at about the 1st 1/5 portion of the scale. Of course, this is true for each range. The following inherent meter accuracy test figures, taken on the 0-10 volt range of a commercial D.C. servicing voltmeter, illustrate this point.

True Voltage	Meter Reading	Meter Error (Volts)
1.0	1.17	+0.17
2.0	2.12	+0.12
4.0	4.05	+0.05
6.0	6.04	+0.04
8.0	8.04	+0.04
10.0	10.07	+0.07

In Fig. 4 the errors (in volts) have been plotted against the meter readings. Notice how much larger the error is over approximately the 1st 1/5 of the scale than it is over the middle 3/5 region and the last 1/5 portion. Notice also that the error is very low around the 4/5-scale point (the region at which many meters are calibrated) and how it

(Continued on page 374)

Luigi Galvani

200th Anniversary

"Father of Electricity" Luigi Galvani opened for posterity a door that has swung ever wider to reveal the world of wonders now termed, in his honor, "galvanic electricity."



(Photo—R. P. S., Paris.)

Italy pays a tribute to the man who inspired Volta, Ampere and other scientist-pioneers by issuing a postage stamp in Galvani's honor. His life spanned the period between the years 1737 and 1798; he died in Bologna, Italy, where he was born.

FROG'S LEGS MARK RADIO-ELECTRICAL EPOCH!

It was only by chance, so it seems, that he was brought, on November 6, 1780, to discover what was later named "Galvanism", which consists in produc-

(Continued on page 364)

LAST SEPTEMBER 9th, we celebrated the 200th anniversary of Luigi Galvani who has often been

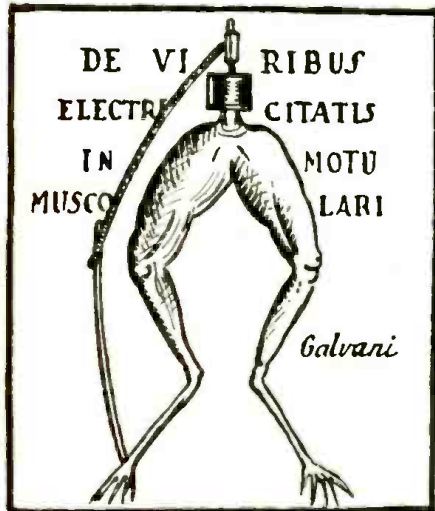

(From R.P.S. photo.)

Under this emblem of Galvani's frog's legs experiments were held, a few years ago, sessions of the first Congress treating of Radio Biology.

called the "Father of Electricity." We will seize this opportunity to recall the life of the great Italian scientist and research worker who gave his name to many a word used now in radio and physics, such as *galvanism*, *galvanometer*, *galvano plastics*, *galvano surgery*, *galvanography*, *galvanic cell* and others which have often resounded to the ears of all those interested in scientific questions.

Luigi Galvani was born in 1737 in Bologna. He studied medicine and became a professor in 1762. His first researches were directed towards natural history and all that concerns life's phenomena.

His studies relative to the brain constitution of birds, obtained such a great success that he decided from that time to devote himself to the study of bird physiology. However he soon realized that the subject he had chosen offered too wide a field of experiment for which he could not find sufficient time and he therefore limited his studies to the close examination of the auditory system of birds.

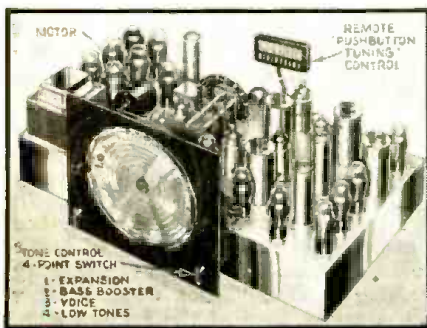

This Midwest set has the new expander.

NEW 20-TUBE SET INTRODUCES DISTORTIONLESS A.F. EXPANSION

This description, exclusive to *Radio-Craft*, of an improved-type expander is of unusual interest to sound specialists.

PAUL P. SMITH

AT THE PRESENT stage of the art, radio reproduction has reached the point where it is difficult to make any major improvements in tone quality or in the control of tone.

All tone frequencies which are broadcast by the present day radio transmitters are received and reproduced by the modern high-grade receiving set. In spite of this fact there are very few people who could be deceived into believing that reproduced music is exactly the same as the original! The one final improvement in produced music, to make the illusion perfect, is to extend the *dynamic range*.

SYMPHONIC ORCHESTRA REQUIRES "DYNAMIC RANGE"

A symphony orchestra is probably the best example of an exceptionally large

dynamic range requirement. The usual symphony audience experiences change in volumes from passages so soft that

it requires absolute quiet of the audience to be heard, to passages so loud they

(Continued on page 364)

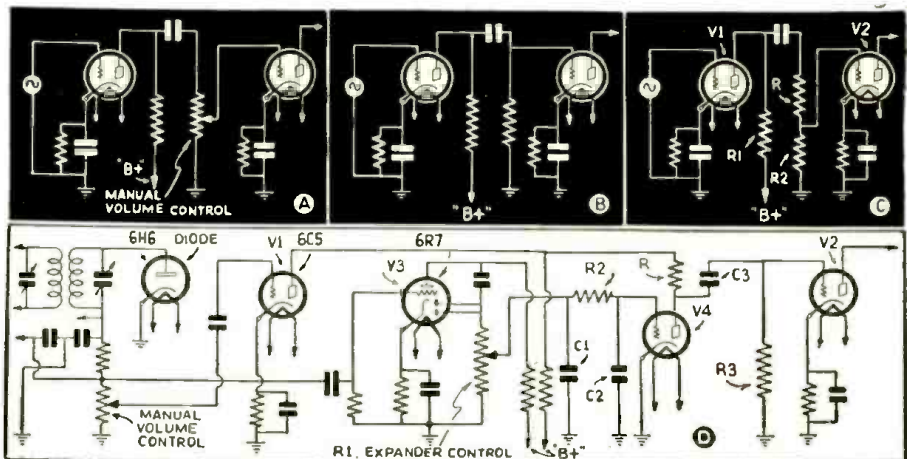

Fig. 1. Electronics reproduces (D) old-style vol. control's advantages (A).

"LEARN-BY-EXPERIMENTING"

BEGINNERS' PRACTICAL RADIO COURSE

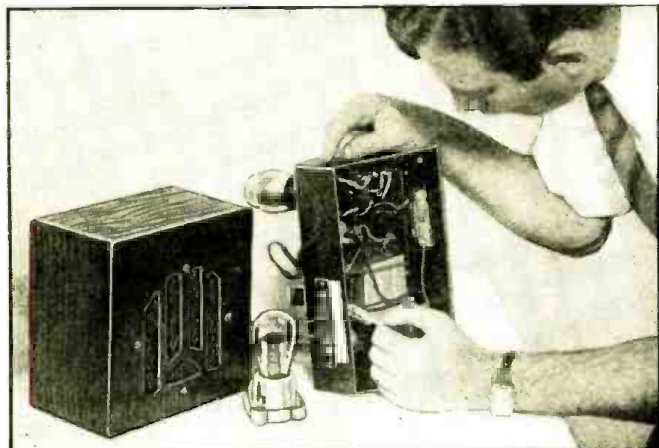

Fig. A. The author, preparing to test the completed power supply (prior to turning on power) with the aid of a neon tube and loudspeaker.

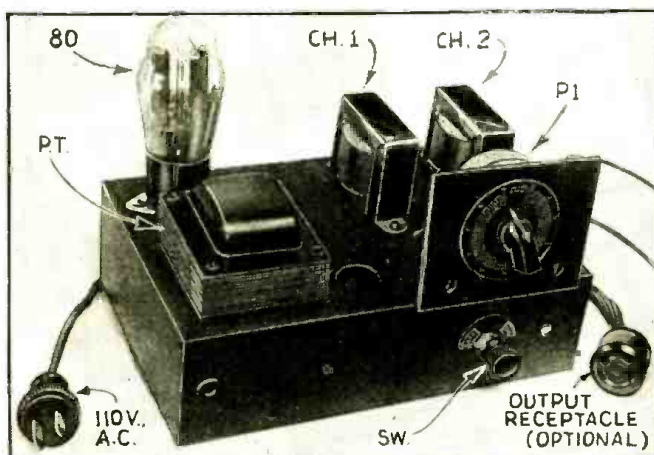

Fig. B. Appearance of the completed power supply. The upper knob on the right controls the variable "B+" voltage output. The lower knob is the off-on switch.

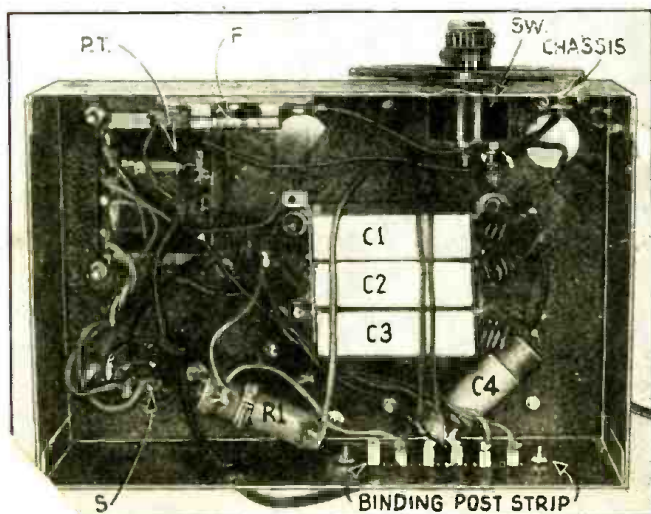

Fig. C. Under-chassis view of the power supply.

EXPERIMENT No. 3

THE POWER SUPPLY AND HOW IT WORKS

New way of learning radio!—You learn basic principles while building useful radio units. The lessons are directed by a man well fitted for the task . . . a radio instructor.

CONDUCTED BY

SOL D. PRENSKY

THIS EXPERIMENT is the 3rd of a series constituting a course of vocational radio instruction, wherein we emphasize "learning by doing" and the use of inexpensive, easily-available constructional material.

While this Experiment is a unit in itself, it is well to call attention here to the list of text book suggestions (given in Experiment 1, October issue) to supplement the practical work. This is essential for a thorough understanding of the principles which are pointed out in the Experiments.

NOTE TO BEGINNERS—Terms in this article that seem strange to you will be found described in detail in the preceding Experiments. (It would be a waste of space, that could be more profitably devoted to discussion of newer items, to repeat the previously-published, more elementary information.)

In considering our topic for this time, namely, Power Supplies, one point stands out as a matter of first importance, namely, that of knowing the right way to handle or even to touch the power unit.

It would be wise that beginners show the same good sense in this respect as that shown by a renowned movie-director who was famed for his versatile knowledge of all of the many angles that go into making movies. "What do you know about electricity?", he was asked. Replied the famous man, "Enough to leave it alone." Many are the men who handled an electrical circuit under the wrong conditions, that later wished they had known as much! Particularly is this true in power supplies, where we commonly encounter voltages of 250 up to 400 V. While this is still below the fatal voltage of the 3rd-rail, it is still high enough to be capable of giving a nasty shock, and to warrant our great respect for the simple means that we will learn to avoid its sting.

The purpose of the power supply, in general, is to furnish electricity of various amounts of voltage and current for the operation of the vacuum tubes. The supply is best considered in 2 parts: (1) the "A" supply to heat the filaments or heaters; and (2) the "B" supply to furnish voltages for the plate current. These 2 are all that are generally necessary, as the voltages for the grid circuit ("C" supply) are usually produced in the set itself by means of resistors through which the plate current flows.

The power supply may be in the form of batteries or a unit operated from the 110 V. socket. While the supply from batteries can be used with any type tube, since the batteries furnish pure *direct current* (D.C.), yet the requirements of modern sets for voltages around 250 V. and for relatively large currents make the use of batteries in

such cases entirely impractical. Even for apparatus requiring less power, the great inconvenience and expense of replacing the batteries as they run down has led to the wide use of the "socket power supply", and heater-type tubes, wherever possible.

The power available at the home socket is, in the majority of cases, 110-V. *alternating current* (A.C.). We will, therefore, confine our attention to this type of A.C. power supply, which, in modified form, is also called a "B' eliminator" (in which case it lacks the "A" supply) or a *power pack* (when it is incorporated in a radio set as an integral part).

PRINCIPLES INVOLVED

The problem presented is to convert the original 110 A.C. line voltage (which includes 105 to 120 V. A.C.) into low-voltage A.C. for the heaters, and high-voltage D.C. for the plate. In this case, the heater voltage is to be 6.3 V. A.C. and the plate voltage from 90 to 250 V. D.C. The 3 fundamental types of current namely, A.C., D.C., and pulsating D.C. (mentioned in Experiment No. 2), are here again involved, so it will be well to start first with the image of the alternating current waveform as shown in Fig. 1B.

Here we see that during the first 1/120th-second, the current rises to a peak in the *positive* direction and then drops to zero. During the next 1/120th-second, the current rises to a peak in the *negative* (opposite) direction and then returns to zero again. These 2 intervals constitute "1 cycle" and each cycle is repeated 60 times each second; thus giving rise to its designation, as *60-cycle alternating current*. It will thus be seen that *alternating current* (A.C.) is always changing its value and direction of flow. Hence the term "alternating" current.

The change (or *step-down*) of this 110-V. A.C. line, to 6.3 V. A.C. for the "A" or heater supply, is accomplished by *power transformer* P.T. where we feed the 110 V. A.C. into the *primary* and take off the lower voltage from one of the several *secondary* windings—one having fewer number of turns. The proportion of turns is such that this secondary has only about 1/17 the number of turns as the primary, or, expressing the same thing in another way, the *step-down ratio* is 17 to 1. The voltage obtained from this secondary is then about 1/17 to 110 V. or 6.3 V.

The change from the 110 V. A.C. line to 250 V. D.C. for the "B" or plate supply involves 3 steps:

1st—The 110 V. A.C. is "*stepped-up*" to a high-voltage A.C.

2nd—This high-voltage A.C. is changed ("*rectified*") to pulsating D.C., as shown in Fig. 1C.

3rd—This *rectified* or pulsating D.C. is smoothed out (*filtered*) to "pure" (or very nearly pure) D.C., as shown in Fig. 1D.

"VOLTAGE STEP-UP" AND "RECTIFICATION"

The first part of this process, "*stepping-up*", is accomplished in the same power transformer, P.T., where we have the original 110 V. A.C. in the primary. We take off about 600 V. A.C. from the high-voltage secondary, which has a step-up ratio of roughly, 6-to-1. The resulting 600 V. obtained in this way is still *alternating*.

In the second part of this process, "*rectification*", it is necessary to convert the 600 V. A.C. to direct current that does not change its polarity, since the *plate* of the radio tube must always be *positive*.

(Continued on page 376)

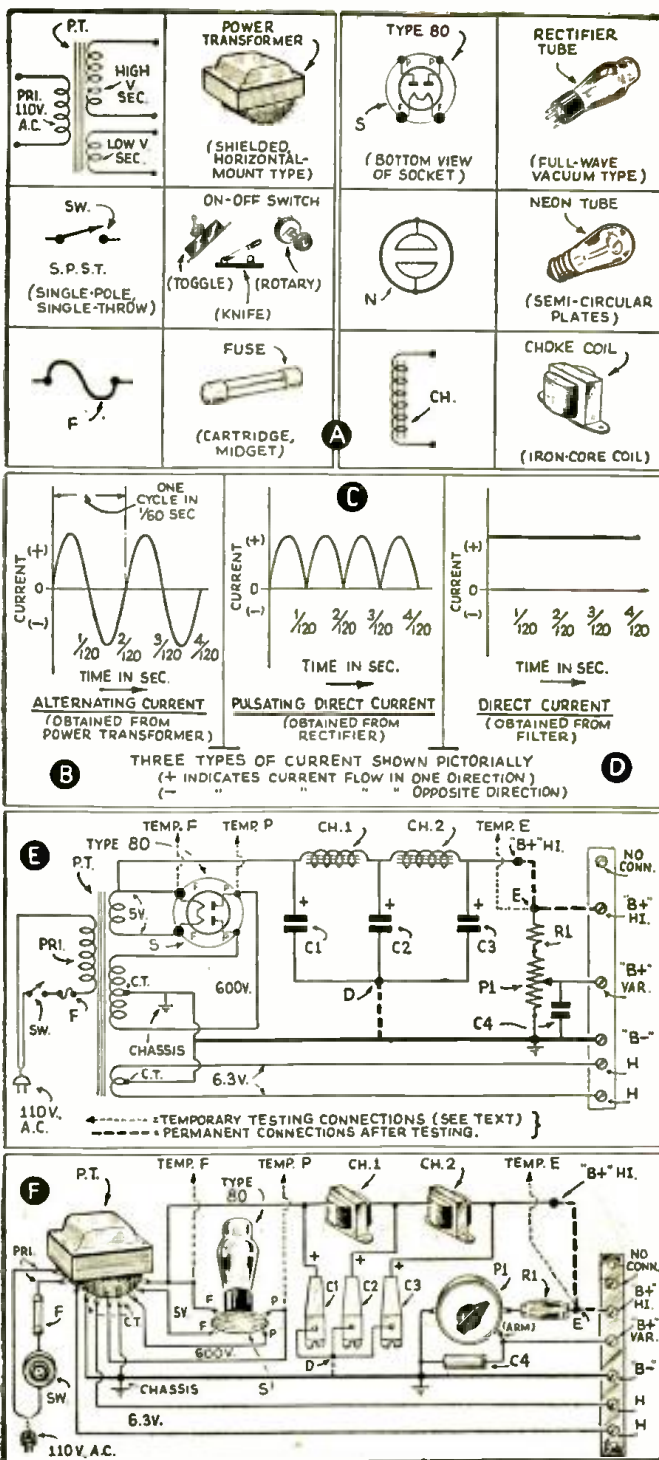

Fig. 1. A, radio symbols of parts used; B, C, and D, the various forms of current prevailing in the power supply; E, schematic diagram of the power supply (note the polarity of the electrolytic condensers); and F, pictorial diagram for those who find it difficult to follow the schematic.

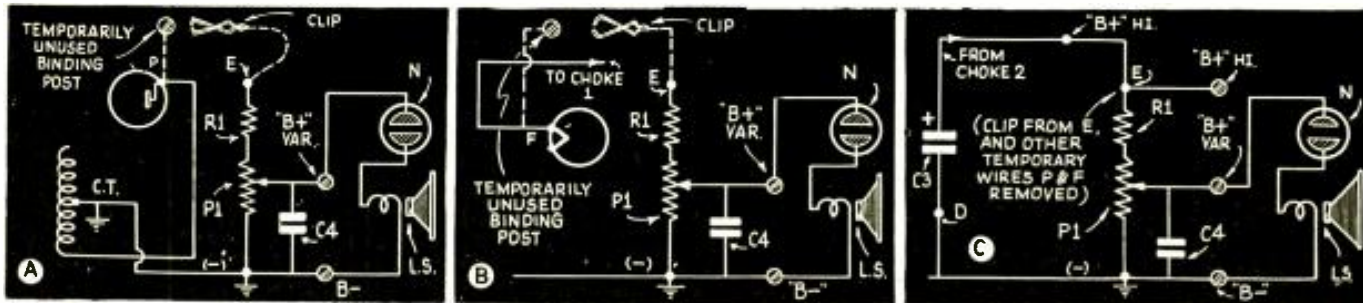

Fig. 2. A, testing the current from the power transformer; B, testing the current from the rectifier tube; and C, the current from the filter section.



A well-planned and equipped sound-on-film recording studio. (Arrow indicates "8-ball" mike.)

FUNDAMENTALS of ordinary types of sound-on-film recording were discussed, in the preceding Part, in preparing the radio man for a relatively thorough understanding of film sound recording. The information is not only of academic interest, and probable utility in the future when television steps to the fore, but may be put to practical use immediately, today, in setting up your own talkies studio. We now continue with the introductory technicalities.

NOISELESS RECORDING

One of the problems of sound-on-film recording has been that of noises due to scratches, dust particles, pieces of emulsion scraped off the film, etc. The noise is, of course, especially noticeable during pauses in the sound. A recent development called "noiseless recording" is now being used

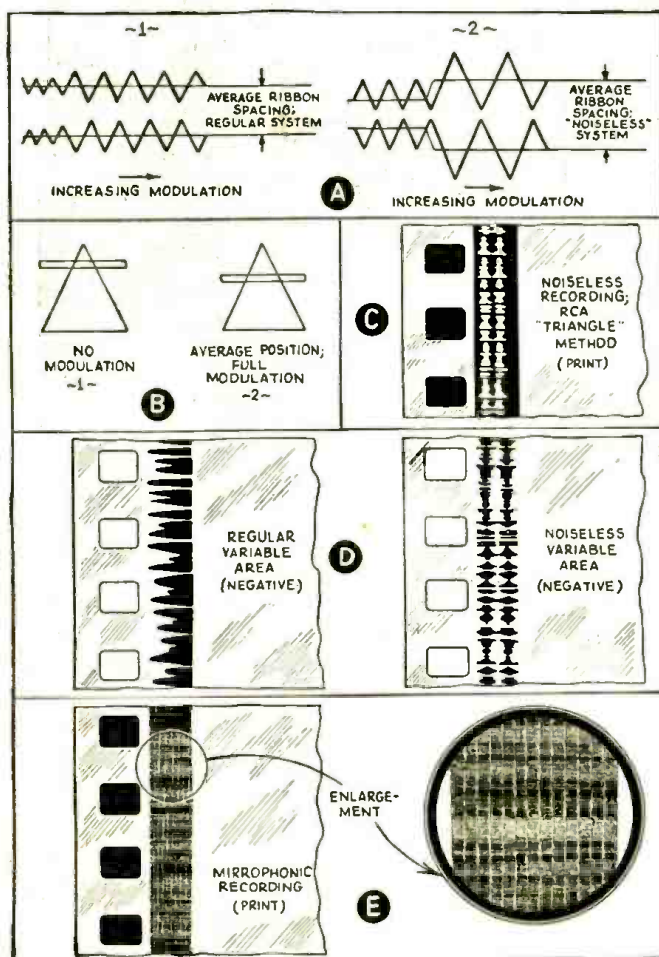

Fig. 2. Mechanics of W.E. noiseless "ribbon"-type, RCA noiseless "triangle"-type, and W.E. mirrophonic recording systems.

HOW TO CONDUCT A SOUND-ON-FILM RECORDING STUDIO

The author—formerly a commercial operator and radio Service Man, and now recording engineer for a New England movies studio—tells you how to make your own talkies.

PRINCIPLES OF RECORDING

I. QUEEN PART IB

to solve this difficulty. There are several methods in use but all use the principle of blackening out the track (on the print) when no modulation is taking place. This means that the negative or original film should be transparent. In other words, when the modulation takes on a smaller value, they vary correspondingly.

In this way, the track is almost completely black (on the print or positive) when no sound is coming over the microphone and dust or scratch marks cannot be projected onto the photoelectric cell in the reproducer. There are 2 motions in the recording unit. One is the rapid variation of the light and dark sections on the track due to the modulation and the other is a slower one which follows the envelope of the audio power.

In the Western Electric system, the valve ribbons vibrate about an average position only while the modulation has a constant value. When it drops, the average spacing of the ribbons is reduced. This does not affect the quality of the sound since a low modulating current requires only a small displacement of the ribbons. If the sound source becomes stronger, the valves take on a greater average spacing and so can accommodate more modulation. In this way it is possible to reduce the ground noise approximately 10 decibels.

Figure 2A illustrates what takes place in this system. The valve opening drops with the A.F. power input. At low values, where ground-noise might cause difficulty, the negative will be more transparent and the print will transmit less light. The action is similar to that of A.V.C. radio circuits where the tube grid voltage not only varies about an average grid bias with the incoming signal, but the average bias is being slowly varied in accordance with the signal.

The corresponding variable-area "noiseless recording" takes place as follows. The recording unit consists of a triangular section which is kept uniformly illuminated by a constant light source and an optical system. The section is placed in front of the sound slit as in position 1 (Fig. 2B) when unmodulated. Here the top of the triangle illuminates only a small section in the center of the slit. (This small area will develop up black in the negative and be transparent in the positive, while the remainder of the track width will be black in the positive).

With a small value of power supplied to the unit, the triangle assumes an average position slightly higher with respect to the slit. With full modulation the triangle assumes a still higher position as at 2. Here half of the track width is exposed and the triangle is free to vibrate the maximum amount in response to full modulation. Figure 2C shows a print (positive) of the RCA "triangle" method of noiseless recording.

ULTRA-VIOLET RECORDING

This is the latest means of recording and is an RCA development. It is designed to overcome certain difficulties of sound-on-film. When a film emulsion is examined under a microscope it is seen to be made up of small particles or grains. These grains determine the resolving power of the emulsion, that is, to what degree of focus a very fine line may be photographed. The film movement is 18 ins. per

(Continued on page 369)

NEW CIRCUITS IN MODERN RADIO RECEIVERS

The details of the modern radio receiver circuits that make them "different" from previous designs are illustrated and described by a well-known technician.

Watch for these diagrams, an exclusive feature, in future issues of *Radio-Craft*.

F. L. SPRAYBERRY.....No. 3

(1) Suppression of Mechanical Resonant Peak in Loud speaker

RCA Model 812K. A tuned circuit resonant to the natural period of vibration of the speaker cone assembly acting as a winding on the output transformer as in Fig. 1A serves to load the output so that signal components of these frequencies will be appreciably dropped in amplitude.

By virtue of the inherent resistance of this tuned circuit, due to iron losses and other causes, it is sufficiently broad to effectively flatten the speaker characteristics. It is designed to simulate the *mechanical resistance component* of the mechanical system, thus having the effect of dropping the energy to the voice coil in proportion to the acoustic rise in output due to mechanical output.

(2) A.V.C. Controls Control-grid and Suppressor-grid in R.F. Stage

General Electric Models F-81 and F-86. An R.F. stage as in Fig. 1B is used only for the broadcast band in these receivers. As the circuit shows, this R.F. tube is provided with A.V.C. control of both the control-grid and suppressor-grid elements.

This provides a more acute control lowering the receiver sensitivity more rapidly at the start of A.V.C. than is usual without permitting detection through cross-modulation. At the start of A.V.C. where the signal is small advantage is taken here to cut it as rapidly as possible. Better and more linear A.V.C. control is thus obtained.

(3) Uses New Tone Monitor

General Electric Model F-107. A new application of automatic audio filtering has been employed in some of the larger of the late-model G.E. receivers.

The 2 auxiliary circuits, Fig. 1C, being attached at intermediate points on the volume control R34, the tone compensation depends on the volume-control setting. The system provides extended and more uniform low- and high-frequency response on strong signals, while for weak signals both "high" and "low" are reduced for greater intelligibility.

Feedback from the voice coil to the volume control serves to reduce harmonic distortion by degeneration allowing for greater undistorted output throughout the entire audio spectrum. Reduction of "boom" of speaker is also acquired through electrical "damping" of voice coil loaded with this feedback circuit.

The double switch, Sw.4, may simultaneously or alternately open or close the connection shown. Four switch combinations give control designated as (1) Normal, (2) Bass, (3) Foreign, and (4) Speech.

(4) Unusual Regenerative System

Philco Model 38-14 Code 121. In Fig. 1D note that the oscillator transformer has 3 windings. To the usual plate and control-grid windings are added a 3rd, small winding which is wired in series with the I.F. plate circuit, below the 2nd I.F. transformer primary, for purposes of feedback.

The plate coil of this 2nd I.F. transformer is untuned so

(Continued on page 359)

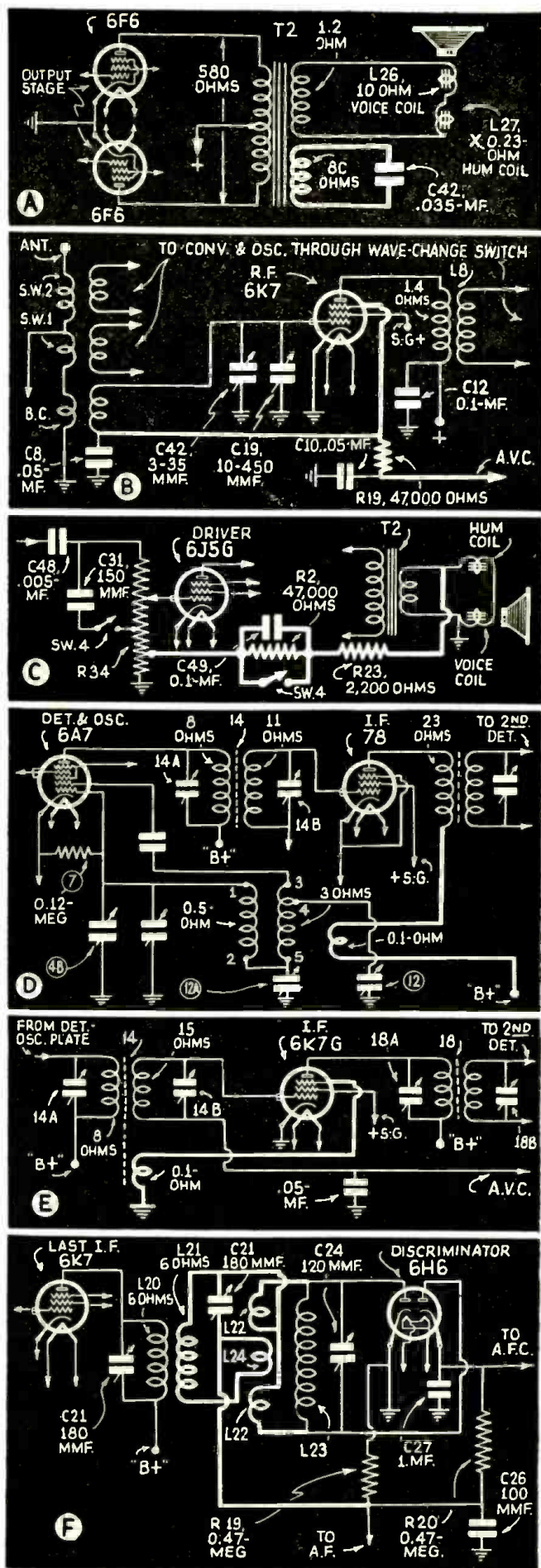

Fig. 1. Heavy lines in the circuits accent the points discussed in the text.

INTRODUCING— "AUDIO-SPECTRUM CONTROL"

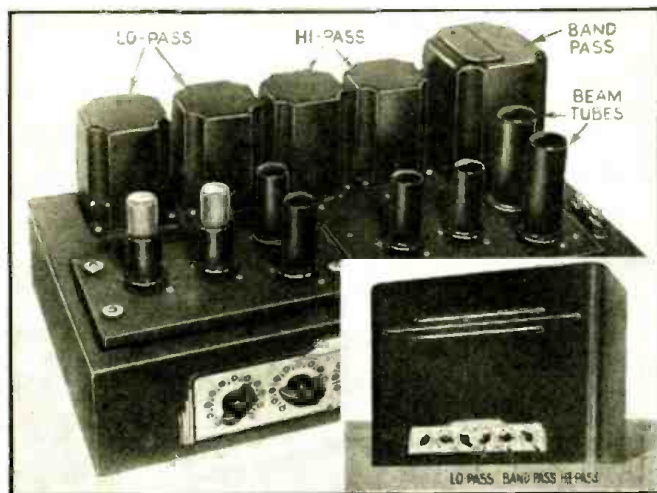

Fig. A. Locations of A.S.C. components; unit TV is mounted under chassis.

Study this new "A.S.C." method of frequency accentuation without the use of shock-excited resonators, equalizers or lossers. It provides a degree of A.F. response control heretofore unattained in sound systems.

A. C. SHANEY

that all low frequencies and their corresponding harmonics are prevalent in the same proportion as those present in the original signal. This phenomenon also applies to the band-pass and hi-pass filter circuit controls (2 and 3, in Fig. 1B).

The degree of accentuation of any one of the 3 bands may be varied by the corresponding band control so as to provide an unlimited degree of flexibility in controlling the over-all response curve. This is clearly illustrated in Fig. 1C. A typical, composite curve at given settings of the 3 controls is illustrated in Fig. 1D.

By manipulating the Threshold Volume control (T.V., in the representative 32-W., class A, beam amplifier, Fig. 2), the amplitude of the complete audio spectrum (having any band of any predetermined composite curve) may be varied by altering a single control. This master control, once adjusted, may remain unchanged; in fact, it is shown in Fig. 2 as a fixed 10-to-1 ratio voltage divider.

Heretofore, distortionless tone control systems were limited to a very narrow band equivalent to the resonating frequency of the tuned high- or low-pass circuit.



AUDIO SPECTRUM CONTROL—or, as we will usually refer to it hereafter in this article, "A.S.C."—may briefly be defined as a system for controlling, within wide limits, the relative response characteristics of the high, low and middle spectrums of an audio-frequency sound reproducing system. The A.S.C. (Audio Spectrum Control)

system accomplishes a number of useful purposes, as follows:

- (1) Restores the high frequencies lost in recording.
- (2) Suppresses natural resonating frequencies of audio transformers, loudspeakers, microphones and pickups.
- (3) Eliminates boominess.
- (4) Squelches feedback.
- (5) Accentuates weak low, middle, or high frequencies without the use of shock-excited resonators, equalizers, or lossers.
- (6) Provides a degree of flexible A.F. response control heretofore unattained.

The need for such a system has long been felt. Proof of which may be found in a hundred-and-one attempted methods for securing this flexibility of control.

GRAPHS SHOW ADVANTAGES OF BROAD-BAND AUDIO-SPECTRUM CONTROL

Conventional tone control circuits provide for a degree of high- or low-frequency compensation as illustrated in Fig. 1A. Regardless of whether either the "high" or "low" are accentuated it will be noted that, because of the slope of the accentuation curve, all frequencies are not amplified equally. This condition introduces *amplitude distortion*. With a broad-band control system such as here described the entire low-frequency spectrum may be evenly accentuated, as shown at 1 in Fig. 1B (over any pre-determined band) so

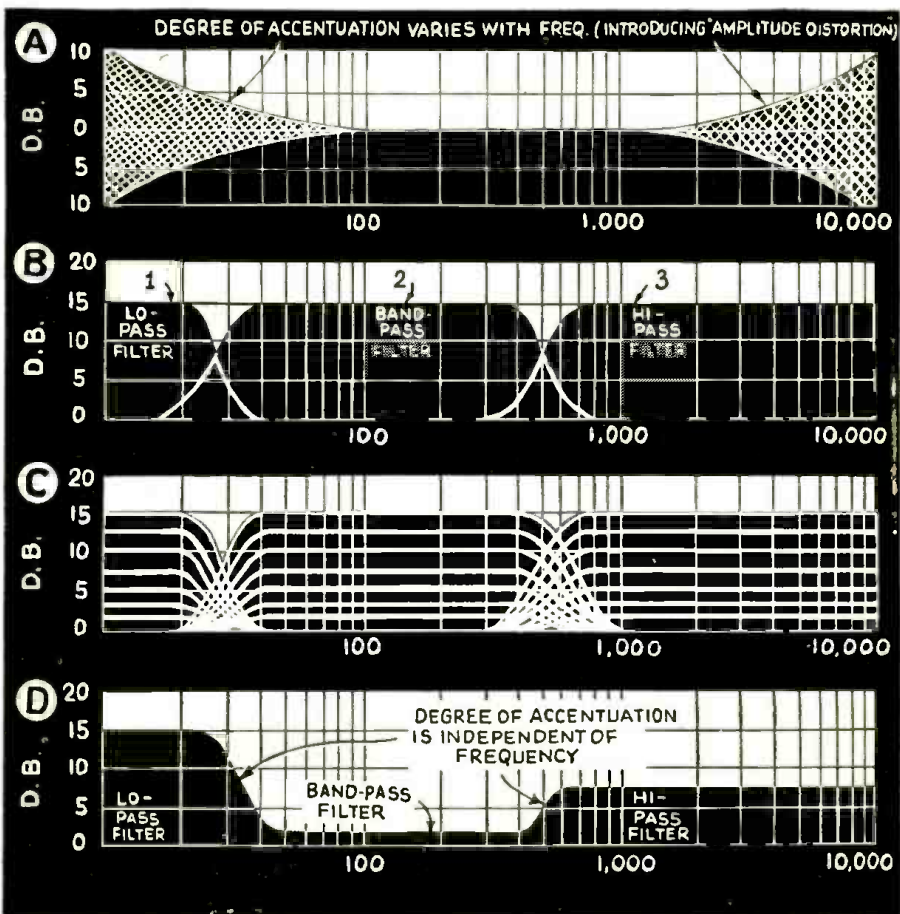

Fig. 1. Comparative frequency-response characteristics of A.S.C. versus previous types of controls.

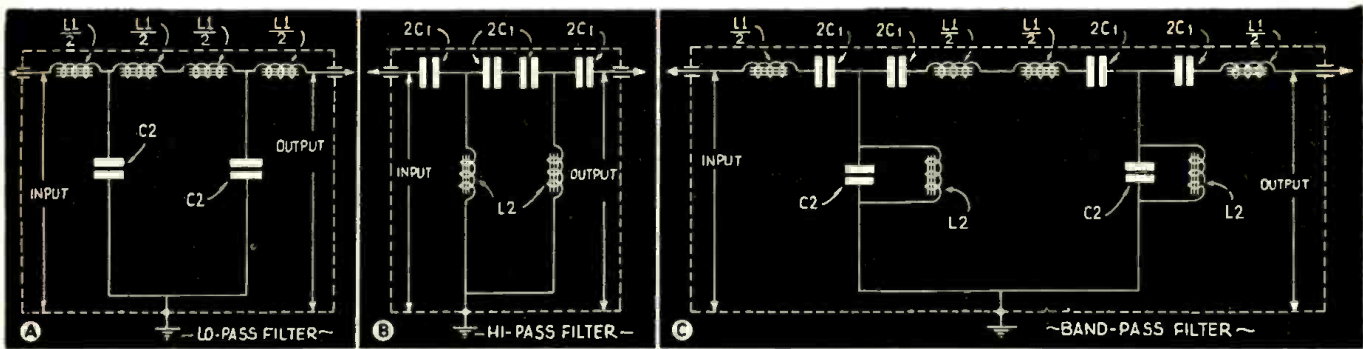

Fig. 3. Schematic circuits of the A.S.C. filter elements shown pictorially in Fig. A. Formulas for finding values appear in text.

LIMITATIONS OF PREVIOUSLY AVAILABLE OR "NON-A.S.C." CIRCUITS

The predominant disadvantages of each type of circuit becomes readily apparent when one analyzes the effects produced by the following existing types:

- (a) **Tone Control**—Random high frequencies are (usually) cut off.
- (b) **Bass Booster**—Maximum bass compensation takes place at some natural (resonant) frequency of the tuned system. Flat response cannot be maintained over a given band.
- (c) **Equalizers**—Cannot be controlled within wide limits. Flexibility of control and response is definitely limited by the pre-assigned characteristics of the equalizer.
- (d) **Compensators**—Provide for varying frequency response characteristics at different levels. Operation control is limited and subject to conditions outlined under Bass Booster.
- (e) **Lossers**—Utilize an anti-resonant circuit providing maximum attenuation at the anti-resonant frequency. Flat response losses cannot be maintained over a wide band.
- (f) **Resonators**—Are as a class similar in circuit, design and performance to bass boosters, compensators, equalizers and lossers. These are all subject to *shock excitation*—a condition which brings about the persistence of resonant signal frequencies after the

original signal dies away. This effect adds boominess to bass and is often referred to as "false bass."

(a) Tone controls, (b) bass boosters, (c) equalizers, (d) compensators, (e) lossers and (f) resonators, have contributed a great deal toward the improvement of frequency-response characteristics encountered in commercial amplifiers and associated accessories; however it has become evident that there are definite limitations in the application of each type circuit which greatly restrict its usefulness in practice.

Fundamentally, the major limitation is that no method has heretofore been perfected which will provide for adequate audio-frequency control over a continuous, predetermined band.

From the foregoing, it is evident that the problem of adequate frequency control has not been solved in commercial amplifiers.

WHY USE A FREQUENCY-RESPONSE CONTROL IF AMPLIFIER RESPONSE IS "FLAT"?

Why should it be necessary to provide a high-fidelity amplifier with a suitable method for controlling its response characteristics?

The answer—in 5 parts—can be found in searching for the reason which necessitated the use of the amplifier and its associated accessories—i.e., for the reproduction of sound in either a natural or pleasing manner.

(Continued on page 381)

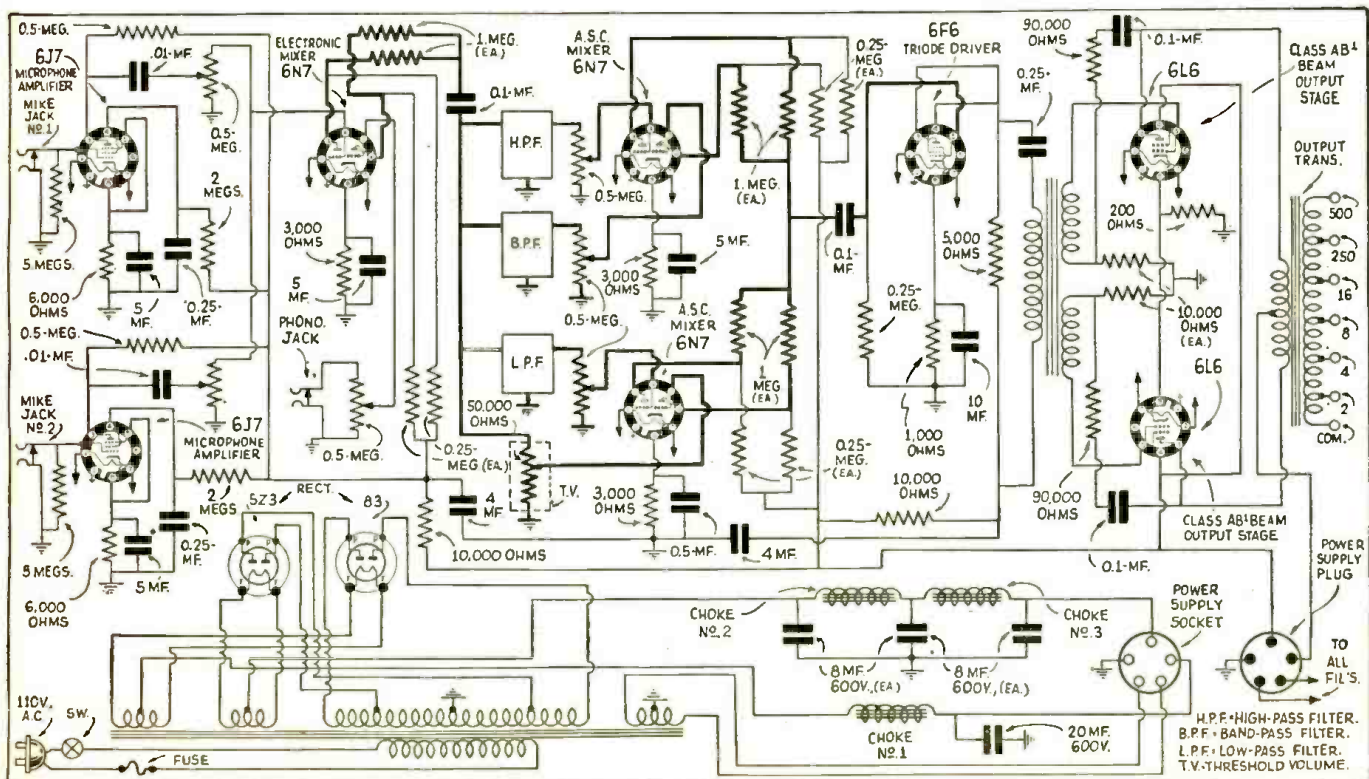

Fig. 2. Diagram of representative 32-W. beam power amplifier utilizing A.S.C. The audio-spectrum control portions of the circuit are shown in heavy lines.



The new "anti-static" loop antenna that permits constant reception of directive radio beam signals.

"SNOW STATIC" BEING BEATEN BY "FLYING LABORATORY"

If this article whets interest—by showing the extent and importance of *just one phase* of radio engineering designed to make flying safer—in aviation-radio as a vocation we will feel amply repaid in having selected this story for *Radio-Craft* readers. Much as we would like to, space does not permit us to print the entire story in one issue or even in two. This article, then, is Part II of the series.

H. M. HUCKE PART II

SAFETY IN FLYING, particularly in these days of "blind" navigation in which the pilot may not see the ground from the time he leaves an airport until he arrives at his destination, owes much to radio. Aviation, not content with utilizing available facilities, has contributed greatly, in research, to solving problems in radio reception that are universal. One of these is *static* which the author discusses from many angles.

METEOROLOGICAL ASPECTS

All atmospheric static results primarily from disturbances in the electrostatic field which surrounds the earth. While the theories regarding these disturbances are not entirely complete, the following viewpoint will be of assistance in understanding the problem:

We can assume that the earth is a huge ball floating in free space. As such it gathers an electric charge which is stored in the atmosphere which surrounds it. The charge near the surface is normally about 35 volts per foot of altitude. This tapers off as the atmosphere becomes thinner with altitude until at 20,000 ft. it is only about 15 V. per foot. (The total voltage between the earth and the outermost reaches of the atmosphere has been estimated at about 1,000,000 V.)

As long as this charged atmosphere remains evenly distributed, a plane may fly through it without suffering from static interference. After taking off it rises slowly enough to allow the charge on it gradually to build up until at 20,000 ft. it would be charged to about 300,000 V. with respect to earth. It would be charged at zero volts with respect to the atmosphere immediately surrounding it.

The air surrounding the earth is not normally in equilibrium due to the action of the sun. The sun's rays heat portions of it unequally and cause it to rise. As it rises, the electrostatic field becomes distorted but under average conditions readjusts itself and retains a reasonable equilibrium. The rising air, however, brings up moisture which condenses to fog and forms clouds.

If the fog forms slowly the electrostatic charges on particles retains a reasonable distribution. If it forms rapidly due to turbulent air currents, the water droplets are churned about. Since the electrostatic charges remain on the droplets, they are also churned about and the cloud becomes unstable electrostatically. Lightning will occur if sufficient electrostatic instability results, thus forming the usual thunderstorm.

When water droplets are carried about by the wind in a cloud they are usually split up into larger and smaller units. Tests indicate that the large droplet is usually *positive* while the fine spray which is separated from it by the wind is usually charged *negatively*. There is considerable question as to whether the mechanical action of splitting the droplets produces the difference in electric charge or whether the difference in charge results from the fact that the fine spray usually is carried upward while the heavier droplets are carried downward. If the charge is due to the different mechanical position of the two types of droplets, it would seem that their position with respect to the earth's electrostatic field

could produce a difference in charge. There is good possibility that differently-charged droplets result from the combined action of the several theories rather than by any one single method.

THE THEORETICAL "SIMPSON CLOUD"

The general theory of thunderstorm formation has been described by Simpson in England and gives a good picture of the situation and may be obtained from any standard text on meteorology.*

Actually, the cloud is the result of rising air entering a cooler portion of the earth's atmosphere. Considerable turbulence results in the rising portion of the cloud and water particles are often carried upward and fall back into the rising current a number of times. If the churning action goes on for a sufficient length of time the water droplets may be built up into large-size hailstones. When their weight becomes great enough so that the rising air can no longer support them, they fall out of the cloud as hail or rain. This churning action produces a turbulent distribution of electric charges on the droplets in the clouds. If we were to fly through such a cloud we should theoretically record a gradual charge from positive to negative as the charged areas are passed.

Actually the theoretical "Simpson cloud" never exists in nature. In the course of our work we flew through and recorded the voltages in about 50 clouds. Some clouds were entered in a number of different directions and at different altitudes. Of interest is the fact that the distribution of charged droplets in a cloud is vastly more random than the theoretical *Simpson cloud* indicates. Our flights indicate that the interior of a cloud is in constant motion and consequently the charged droplets are undergoing continuous change of position. The flight tests further indicated that if any comparison of antennas is to be of value it must be made by having the antenna on the same aeroplane and switching from one antenna to another in a second or less. Such switching back and forth between 2 antennas must be repeated many times before comparisons can be trusted. We obtained most useful results in the larger clouds.

STATIC CLOUDS ARE OF 2 TYPES

From a meteorological standpoint there are roughly 2 types of clouds in which static will be formed. The first is the simple *warm-air thundercloud* formed by the rising of moisture on a hot summer day. The second is formed by 2 air masses of different temperatures coming together and forming an *air-mass "front."* Either type varies widely in the amount of turbulence and lightning does not necessarily result in every case. Even though lightning does not occur, the turbulent mixture of plus- and minus-charged snow, rain, or ice particles is present.

The warm-air type of thundercloud usually reaches its maximum early in the afternoon and begins to subside as the sun goes down. The cloud generally begins to spread out in the evening and the updrafts are less violent. When in this condition it is satisfactory for flying and

will give good snow-static areas for test purposes. The static usually disappears before midnight.

The "front" type of cloud persists on through the night and will show static areas at practically any time. In winter, the "fronts" cover areas hundreds of miles long and are most troublesome from a radio flying standpoint. Summer thunderstorms may be avoided by flying around them but this is impractical for the winter air mass fronts. In mountainous country, air-mass movements are usually broken up into secondary turbulent areas over the crests of the mountain ranges. These turbulent areas also usually contain charged moisture particles.

Whenever the line of the air-mass front lies at *right-angles* to the line of flight the static area is traversed in a short time. When the front is *parallel* to the line of flight the plane may be in the static area for several hours. This is the condition which constitutes the greatest hazard to radio navigation. Since the air-mass front is usually not perpendicular to the face of the earth, but lies in a horizontal plane like a thin slice of cake, it is possible to avoid the static area by changing altitude. This is a problem in which our meteorologists can advise the pilot and thus assist him in remaining in static-free areas. Considerable data must be gathered on this subject before consistent predictions of static areas can be made.

THE GENERATION OF STATIC ON THE PLANE

If a plane *slowly* climbs up through a cloud in which the charged droplets are uniformly distributed and in electrostatic equilibrium no snow-static disturbance is heard in radio reception. As it climbs, however, it must rise from an area of one charge to an area of greater charge with respect to the earth. The plane is, in effect, a large metal body which may have on its surface an electrostatic charge in the same manner as the earth has a charge. The charge in the atmosphere immediately around the plane must, therefore, gradually increase as it climbs upward and decrease when it glides downward.

With a sharp 2-ft. steel point projecting from the rear of the plane, discharges up to 10 or 15 microamperes have been measured while ascending or descending through charged fog particles. No static was heard in this condition. As long as the charging and discharging of the plane does not exceed a certain rate no static is heard. Since there must be a difference of potentials between the plane and surrounding atmosphere before discharge can take place, it is apparent that the plane's potential must exceed a certain value before static is heard.

In such a condition the 40-ft. short-wave antenna on top of the plane gave no noticeable static in the shortwave receiver until a continuous current flow of 2 microamperes was exceeded. The receiver had a 1/2-meg. resistor across the antenna input through which this current flowed. The D.C. voltage drop across this resistor was therefore 1 V. but the ripple superimposed on this D.C. voltage must have been only a few microvolts if it was of a random nature. *Thus the noise in*

(Continued on page 375)

*Humphries' "Physics of the Air."

RECENT APPLICATIONS OF THE "ELECTRIC EYE"

A laboratory professor, on the faculty of a famous university, tells you in abbreviated description how new electronic developments are being applied in many important ways.

K. GUENTER.....PART II

LAST MONTH, in this well-presented, highly enlightening treatise on the application of photoelectric cells to scientific fields other than radio (specifically—chemistry, biology, physiology, etc.), we told you about various types of photocells; and in addition a few of the applications that their specific characteristics made purely convenient.

For instance we described the barrier layer or rectifier photocell and how its operation is based upon the *Becquerel effect*; we also described the glass enclosed or gas-filled photocell which depends for its operation mainly upon the *Hallwaches effect*. In discussing the practical applications we told you about the *automatic electrophotometer*; Dr. Lange's *photoelectric colorimeter*, an easily-constructed home-made instrument, *automatic titration apparatus*, and the Nicolai method of utilizing the PE. cell to observe life processes. We now continue with a further discussion of electronic developments which probably will be new to the average technician.

ADDITIONAL APPLICATIONS OF THE PHOTOCCELL

Differential Photometer. By a simple procedure a rectifier cell may be converted into a *differential-type* cell. G. A. Millikan shows how such a cell can form the nucleus of a "colorimeter" which in his own words "is relatively cheap, simple, and quick to use, can be adapted to very small quantities of fluid, and has a linear calibration curve."

The surface of the copper-copper-oxide cell (Fig. 3A) is divided into 2 halves by a scratch along one diameter, and the terminals rest lightly on the metallic film, one on each half. The cell measures directly, and without driving potential, the difference in the amount of light striking the 2 halves.

Two suitable filters (Wratten gelatine filters) of complementary color are fastened in front of the cell. They are shifted from side to side until the galvanometer is brought to a convenient balance point during calibration. The adjustment is so made that the 2 end-points give deflections which are about symmetrical, relative to the zero point. This use of a balance system simplifies operations, and reduces to a minimum the effects of fluctuations in the intensity of the light source. A cheap, robust galvanometer is used: sensitivity, 10⁻³ amp.; resistance, 800 ohms; period, 1.2 sec.

The Time Machine—Hartridge and Roughton Method. This is not exactly like the famous product of H. G. Wells' fertile imagination, but in both instances the operator enjoys the privilege to choose the time scale at his convenience. Suppose you wish to study a chemical reaction (in blood pigments, for instance) which is complete within 1/1,000th of one second. Any ordinary method of measurement available in the laboratory would be hopelessly too slow for this purpose.

The principle of the "flow method" has been successfully applied by Hartridge and Roughton to the study of blood pigments. Look at Fig. 3B: The fluids V and R, containing the 2 substances which are to react, are pressed into the mixing chamber. Mixing is complete within about 1/1,000-second.

The mixture streams upwards through the observation tube. It is apparent that the distance of a given point on this tube from the mixer corresponds to a certain time after mixing, depending upon the rate of flow. If the latter is known this time interval can be readily determined. By moving the photoelectric colorimeter up and down the observation tube and taking measurements at a number of points, the time

(Continued on page 375)

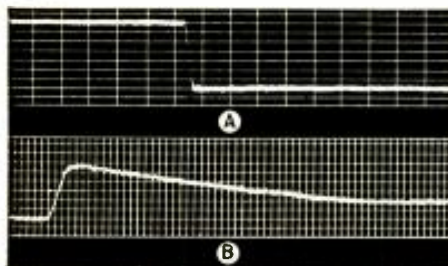
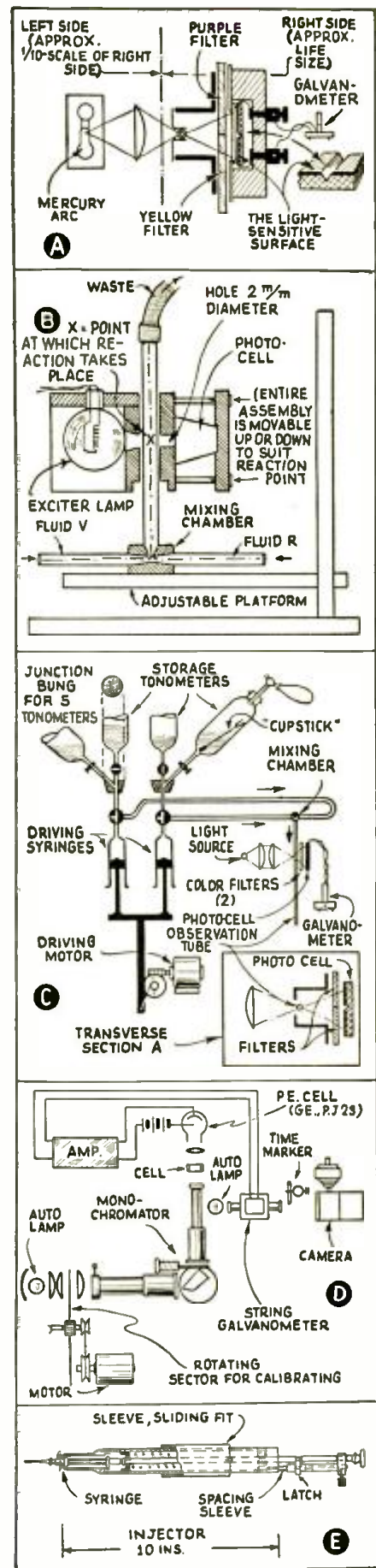

Fig. 5. Reactions: A—dye and water; B—blood (pigment) and peroxide.

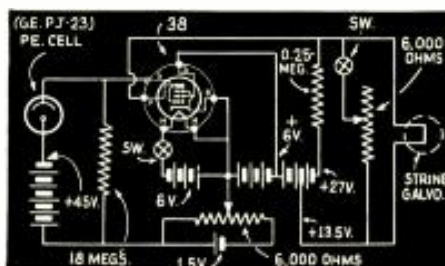

Fig. 4. Circuit, recording and reaction meter (see Fig. 3D, 3E, and Fig. 5).

Fig. 3. A, the Differential Photometer; B and C, photoelectric machines for determining the elapsed time of chemical reactions; D, a Recording Reaction Meter; E, an "injection gun" used with the Reaction Meter.

FIRST PRIZE.....\$10.00
 SECOND PRIZE.....5.00
 THIRD PRIZE.....5.00

Honorable Mention

EXPERIMENTERS: Three cash prizes will be awarded for time- and money-saving ideas. Honorable mention will be given for all other published items. Send in your best "kinks"!

SHORT-CUTS IN RADIO

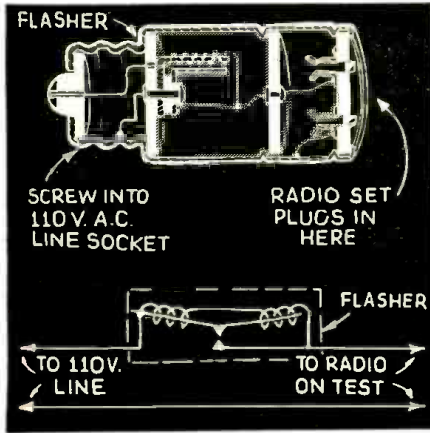

Fig. 1. Scheme for checking "intermittent" set faults.

FIRST PRIZE—\$10

INTERMITTENT CURRENT FOR SET TESTING. A very good auxiliary test for sets just repaired in the shop is to connect an ordinary heavy-duty flasher in the line to the set, for a period of an hour or more, as shown in Fig. 1.

I have been using this test for some time and have found a number of condensers, etc., which break down under this test. These units would have broken down shortly in the customers' homes.

If figures were compiled, they would probably show that a very large percentage of all set breakdowns occur either when closing or opening the power switch, the resulting surge being responsible for this condition.

STANLEY DAVIS,
Vancouver, B. C., Canada.

SECOND PRIZE—\$5

PHONO PICKUP MAKES MICROPHONE! A usable though not very sensitive microphone is easily improvised from a standard phonograph pickup, which is not harmed—and indeed, need not even be removed from the set—for the operation. A handy stunt, to say the least, if a regulation microphone (or a headphone or extra loudspeaker) is not available.

A 2½-in. disc of light but rigid metal has its edge soldered to a length of stiff brass or copper wire of the same diameter as a phonograph needle. (See Fig. 2.) The wire is then clipped short, so that when it is inserted in the pickup's

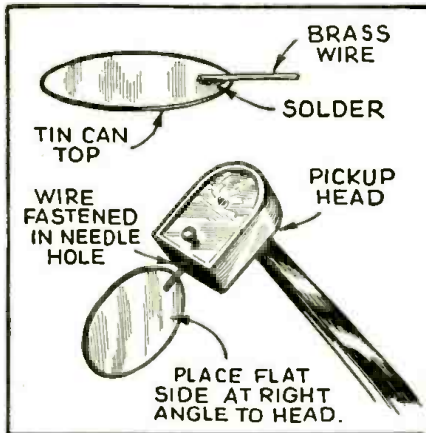

Fig. 2. Darn clever, this New York lad.

needle holder, the edge of the disc just clears the pickup. The plane of the disc should be in the same direction as the armature in the pickup; that is, at right-angles to the width of the pickup head.

(Another means of fastening is to solder the wire at the center of the disc, and to make a right-angle bend in it about ¼-in. from this point, running it from there to the pickup, as described. In the latter case, best results will be obtained if the disc is about 3½ ins. in dia., and is supported around the edge.)

If used with a regular recording amplifier, or a high-grade P.A. amplifier, equipped with high- and low-frequency tone controls and having sufficient gain to operate from crystal, condenser, dynamic or velotron output, considerably better operation may be obtained; greatly improved tone quality is then readily achieved.

C. O. JONES

THIRD PRIZE—\$5

HOME-MADE SET DIALS. In making dials for receivers, meters, etc., the idea shown in Fig. 3 will enable you to have a neater job than can be secured in the ordinary way.

Make a master dial, calibrating as desired (this may be merely a sketch), then enlarge to scale, on Bristol board, to 12 ins. or more, and draw as carefully as possible in India ink. Take the drawing to a photographer, having him make a negative; and then prints, with the portrait camera, to the size you want, on heavy paper. A sample dial I made this way for an all-wave

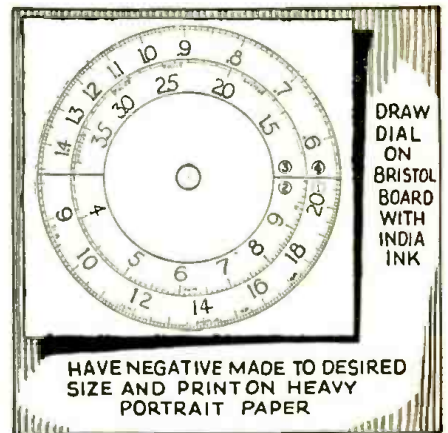

Fig. 3. Make your own all-wave dial to suit.

receiver is illustrated; the original was 10½ ins. in dia.

(A simpler scheme than using a photograph would be to get a "glossy photostat." This idea has been mentioned in past issues of *Radio-Craft* in connection with other types of panel escutcheons.—Editor)

D. P. HARTLEY,
Jasper, Alberta, Canada

HONORABLE MENTION

A MULTI-TAP SWITCH FROM OLD VOLUME CONTROL. A good switch may be easily made from an old Frost potentiometer by removing the resistance element and drilling as many circumference holes as needed for taps.

Roundhead screws ground flat on the top (and concave if possible) are used as taps.

Remove the contact arm and cut it back as indicated in the sketch. Fig. 4. This will allow the contact point to slide back further to clear the heads of the screws. Stops may be made by bending the small pieces of metal used in the original control to hold the ends of the resistance element.

FRED BOETTSCHEK,
(Radio W211E)

HONORABLE MENTION

REPAIRING LOUDSPEAKER SPIDERS. In cases where dynamic loudspeaker rattle is caused by fatigue of the spider or some similar (Continued on page 371)

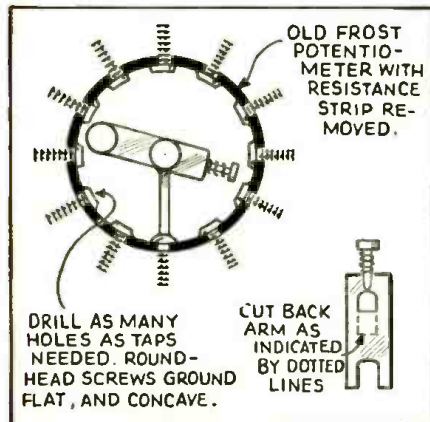

Fig. 4. Another version of the switch-from-potentiometer idea.



Fig. 5. An anti-rattle idea that increased loudspeaker life.

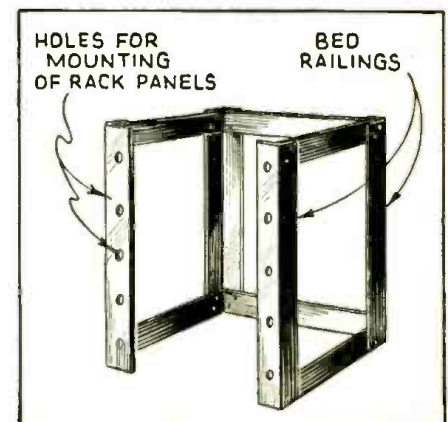

Fig. 6. A trip to the junkyard, and the use of this kink, saves dollars.

HOW TO BUILD THE "ALARMCLOCK" WALL-RADIO SET

In this Part the author tells how to build the cabinet; and how to add the intercommunication feature. This feature was incorporated in the design at the suggestion of R. D. Washburne, who collaborated on the design of the set.

N. H. LESSEM PART II

LAST MONTH we discussed the construction of the chassis of this luxurious (but highly practical) radio receiver "pegged" the "Alarmclock" Wall-Radio Set. Now we will describe the construction of the cabinet, how to add the intercommunication feature and how to connect the time-clock to automatically operate the radio set and other electrical apparatus. Each item will be discussed only briefly since the constructor will not be held strictly to the author's specifications. The cabinet, for instance, can be shaped to any desired pattern or built to match the living-room furniture instead of the bedroom as was the author's; or the intercommunicator can be made to operate between the living room and the garage instead of the bedroom upstairs and the kitchen below; . . . so here goes!

THE CABINET

All the measurements necessary to build the cabinet are given in Fig. 2. The design was intended to be old-colonial, but what it actually is we don't know. The wood is solid maple, 3/4-in. thick, except the front panel which is (Continued on page 358)

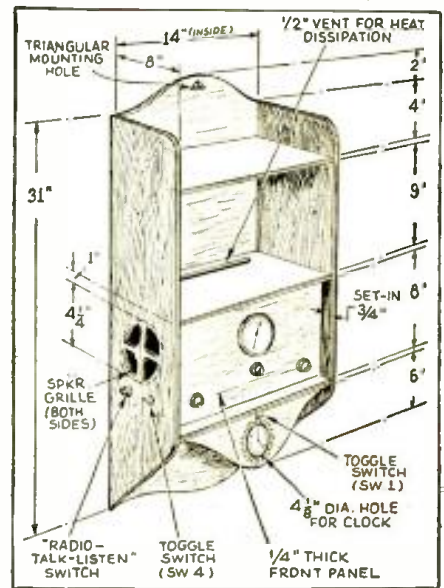

Fig. 2. Dimensions for constructing the cabinet.

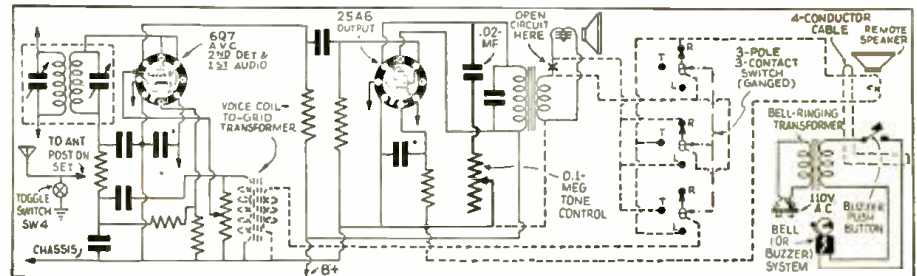

Fig. 3. The dotted lines are the connections necessary for adding the intercommunicating system.

NEW 15-W. AMPLIFIER FEATURES HIGH GAIN, LOW HUM LEVEL

This amplifier description meets repeated requests for construction data on a low hum, medium-power amplifier.

G. McL. COLE

IT IS COMMON KNOWLEDGE that the main job of an amplifier is to increase the mean power level. However, this particular function of the amplifier is satisfactorily accomplished only, when in so doing, true high fidelity, low hum level and low distortion are also characteristics of the amplifier. In

addition to these characteristics the modern amplifier must be a high-gain unit in order to accommodate crystal and velocity microphones. Such an amplifier is the "Stentorian" 15-W. unit, about to be described.

The general characteristics of the amplifier are:

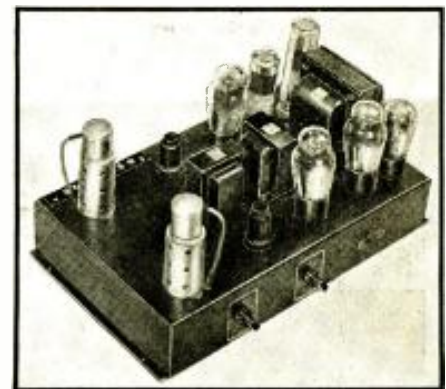

Fig. A. 15-W. hi-gain, low-hum-level amplifier.

- Output 15 W.
- Number of stages 4
- Gain from crystal mike 120 db.
- Gain from D.B. mike 107 db.
- Harmonic content at 15 W. 2 1/2 %
- Hum level at full output -8 db.

The use of a high-gain amplifier simply means that all disturbances will be amplified along with the signal. Hum pick-up and line noise, which would be unnoticeable in a low-gain unit show up and are most annoying in an amplifier of this type if they are not properly squelched at the very outset. Consequently, it is mandatory that the input leads be well shielded and that this shielding be well bonded to the common ground.

(Continued on page 362)

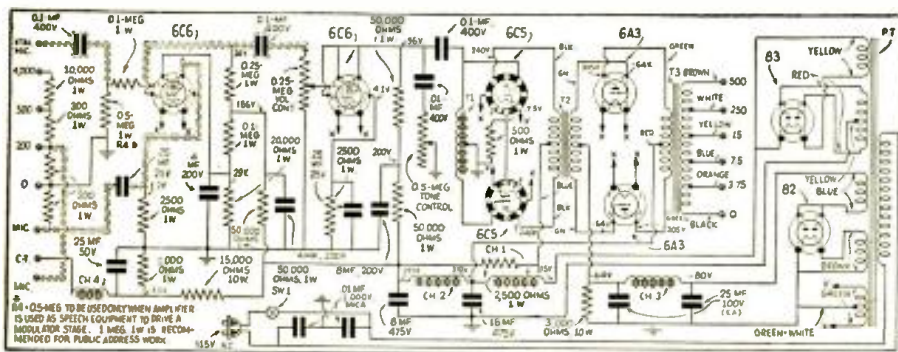
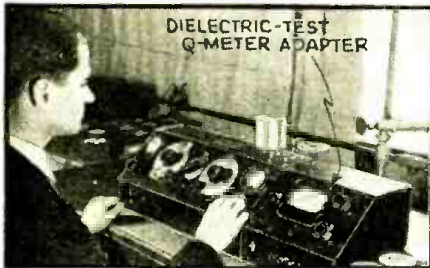

Fig. 1. Schematic diagram of the amplifier. All operating voltages necessary for testing are given.

THE LATEST RADIO EQUIPMENT

This department brings to you each month the newest developments in electronic, radio and public-address equipment. Aggressive technicians use this department to keep posted on the newer and better ways of doing things.



Add-on unit at right acts as vernier. (1497)

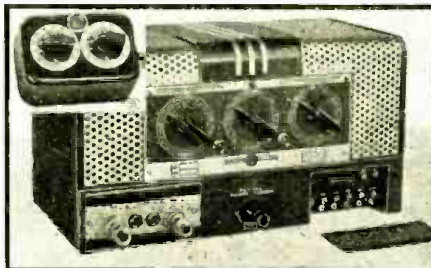

New P.A. amplifier is "streamlined." (1501)



A veritable service shop. (1502)

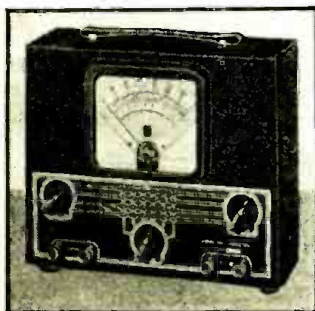

New "super-analyzer." (1498)

DIELECTRIC-TEST ADAPTER FOR THE Q-METER (1497)

A STILL greater degree of accuracy in the measurement of *Q*, power factor or dielectric constant of insulating materials (quartz, for instance) and small condensers within the frequency range of 100 kc. to 10 meg., and ordinarily producing circuit changes of only 2%, is provided by the type 106-A Dielectric Unit here shown in use.

The Dielectric Unit becomes substantially a *vernier* when used in combination with the well-known Q-meter (*Radio-Craft*, January 1937, item No. 1230, pg. 415) which it matches in general appearance.

The 50-microampere meter of the dielectric-test adapter permits expanding the normal scale of the Q-meter proper to approximately 4 times normal.

NEW SUPER-ANALYZER (1498)

(The Clough-Brengle Co.)

HERE IS a test instrument that is "super" not only with respect to its ability to test superheterodynes but also because of certain design features and test ranges.

The term "functionalized switching" is used in reference to the means of positive-contact rotary switches that dispense with pin-jacks and binding posts; full-open-face etched scale permits all A.C. ranges to be read on the same scale thereby avoiding confusion incident to use of 2 or 3 different A.C. scales engraved on the same meter dial.

All circuits are designed to maintain accuracy with temperature changes.

The D.C. voltage ranges are: 3.5, 7.0, 35, 140, 350, and 1,400 V. at 20,000 ohms/volt. A.C. ranges: same,

with the high sensitivity of 7,000 ohms/volt. Ohms scales: 0-3,000, 0-30,000; 0-3 meg., and 0-30 meg. Decibel ranges: -14 to +61 db., using 5 multipliers. The minimum db. resistance of 35,000 ohms permits bridging of high-impedance audio circuits with negligible error.

This (model 120) instrument is completely shielded. Supplied with test leads.

INTERPHONE-TYPE MICROPHONE FEATURES GRIP-TO-TALK SWITCH (1499)

A COMMUNICATIONS-TYPE microphone especially designed for use in the better types of interphone systems incorporates a grip-to-talk switch. A light grip on the standard will cut the microphone in; releasing grip cuts unit out. A type D-104 crystal microphone, but having improved frequency response particularly suitable for interphone service, is used. Includes an 8-ft. length of rubber-covered cable.

NEW LINE OF UNIVERSAL REPLACEMENT ELECTROLYTICS (1500)

(Cornell-Dubilier Electric Corp.)

RADIO SERVICE MEN will be glad to learn of the new type UM series of universal replacement electrolytic condensers, for A.C.-D.C. sets, recently announced. These condensers were developed to eliminate the previous great expense to Service Men in stocking exact duplicates, and the time consumed in obtaining them. It is said that any A.C.-D.C. receiver may be quickly

and economically serviced by stocking only the 3 types of replacement condensers illustrated. Leads are color coded.

NEW P.A. LINE FEATURES REMOTE MIXER (1501)

(RCA Manufacturing Co., Inc.)

A NEW LINE of improved public address and sound reinforcement equipment—"streamlined" for compactness and trim appearance—which includes among other outstanding technical developments a unique electric mixing unit (see insert A) for remote control of sound distribution, has been announced by the Commercial Sound Section of a well-known radio set manufacturer.

The remote mixer enables operator to control volume from a strategic position in an auditorium or other gathering place and regulate it according to changing audience conditions, at will. Heretofore, the operator has had to work at the amplifier, which is usually behind the scenes, where inputs from the microphones were mixed by sheer guesswork. Remote mixing with the new equipment is accomplished electrically in the amplifier rather than in the signal circuits, thereby reducing the necessary wiring, eliminating the need for shielding and avoiding other difficulties ordinarily encountered.

The 24-W. amplifier (illustrated; model MI-4284) in this new P.A. line utilizes beam power output tubes, with reverse feedback circuit, and has automatic base compensation for phonograph reproduction. Frequency response, 60 to 10,000 cycles within 2 db.; gain, 107 db. to 1,000 cycles. Power output, 24 W. at 7 per cent distortion. (Continued on page 380)

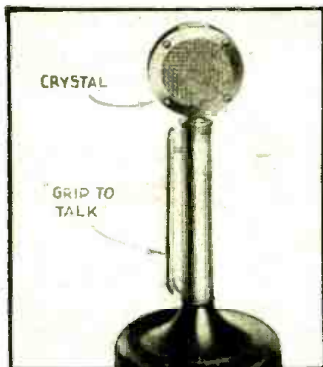

Special interphone mike. (1499)

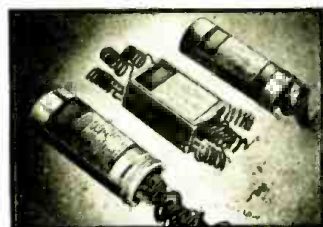

Replacement electrolytics. (1500)



Directional mike. (1503)

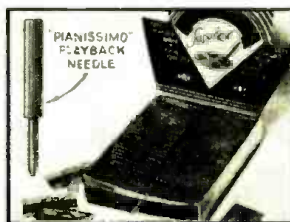

These new needles playback any record many times. (1504)



New test unit. (1505)

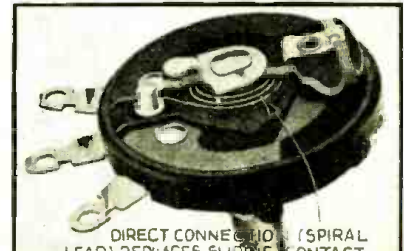

At last! A noiseless potentiometer. (1506)

Name and address of any manufacturer will be sent on receipt of self-addressed, stamped envelope. Kindly give (number) in above description of device.

Service Men may write, requesting answers to specific service questions. Address inquiries to Service Editor. For questions answered by mail, a service fee of 25c per question is made.

SERVICING QUESTIONS & ANSWERS

Note: An effort is being made to maintain 48-hour service on mail inquiries, from Service Men, addressed to "Servicing Questions & Answers." Let us help you on that rush job.

DISTORTION, OSCILLATION

(32) R. S. Hyry, Detroit, Mich.

(Q.) With a Philco "high-efficiency" aerial connected to a model Philco 38-620 receiver, nearby stations are received with distortion and squealing. Many stations, including distant ones, have a muffled tone. Upon the short-wave band, reception is normal but noisy.

When the aerial is disconnected, there is no noise and local stations come in OK, but no "distance" is received. This set has only been in use a few days and I believe the aerial to be the source of the trouble. Do you believe the speaker to be incapable of handling the volume of powerful stations, since it is quite a small one? What would you suggest?

(A.) From the symptoms described in your inquiry, it is reasonable to assume that the difficulty mentioned is attributable to the receiver itself and not caused by the antenna. Distortion and oscillation with antenna connected and a strong signal tuned to resonance on the receiver is probably due to insufficient, or lack of, A.V.C. voltage or both. Without this controlling voltage, the R.F. or I.F. tubes (or both) become seriously overloaded, resulting in the above-mentioned symptoms. In the Philco 38-620 receiver, no A.V.C. voltage is placed upon the 6K7G I.F. stage. Should the 0.05-mf. grid filter condensers in the R.F. 6K7G and 1st-detector 6A8G grid-returns prove intact (a short-circuited condition or excessive leakage in these condensers

will cancel out the A.V.C. voltage), it may become necessary to connect the I.F. 6K7G into the A.V.C. circuit. This is easily accomplished by first disconnecting the brown secondary lead of the 1st I.F. transformer from ground or chassis. This secondary-return lead is then connected into the A.V.C. circuit through a 0.1-meg. carbon resistor and bypassed with a 0.05-mf. condenser as shown in Fig. Q.32B. The original circuit is pictured at Fig. Q.32A.

FADING

(33) Joseph Yarin, Yonkers, N. Y.

(Q.) I have a Stromberg-Carlson model 145L receiver. After playing a few hours, the pilot lights begin to dim out and reception fades away. When the line switch is turned off and on again, the receiver operates for another half hour and the same trouble develops. This happened a few months ago but when I replaced the electrolytic filter condensers with new type dry units, reception was satisfactory until now. Is it possible that the heater winding of the power transformer shorts when fully heated? What do you advise?

(A.) The symptoms described in your inquiry point almost conclusively to heater wiring shorted or shorting to the chassis, thus grounding or shorting the heater winding. The insulation of these heater wires is poor and produces the trouble of which you complain. Obviously, the only remedy to correct the difficulty consists of renewing the filament or heater wiring from socket to socket, if the transformer is yet intact.

When the filter condensers were replaced a few months ago, the filament leads were disturbed, or moved about, just enough to clear

the shorted condition for the time being.

HUM, LOSS IN POWER

(34) F. S. McLeod, Yonkum, Texas.

(Q.) I have a Midwest 11-36 all-wave receiver, which has developed a very loud hum. Volume is not as good as it should be on the broadcast band and on short-wave bands only picks up the more powerful stations such as W3XAL, DJJ, GSJ, etc.

The 8 mf. and 16 mf. wet electrolytic filter condensers were suspected but proved to be OK. (Continued on page 361)

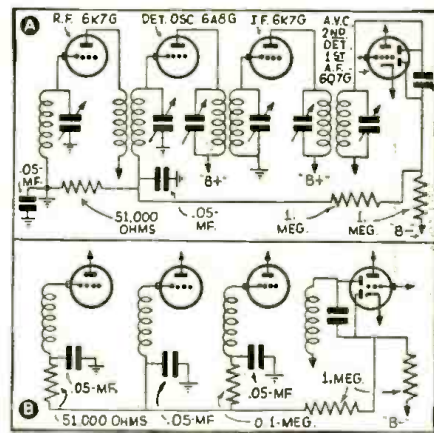

Fig. Q.32

OPERATING NOTES ANALYSES of RADIO RECEIVER SYMPTOMS

Crosley 120 Series. Here is a hint concerning both the Crosley 120 series and National Pfanstiel sets using dynatron oscillators.

Because type 24's now available have "treated" (carbon-coated) plates and will not afford circuit oscillation in dynatron circuits, the Service Man is "on the spot." However, a type 57 tube can be easily substituted for the 24. The tuned circuit need not be disturbed. A dynatron oscillator has its control-grid grounded or at cathode potential. The circuit used in the change is shown in Fig. 1. If the set has short-wave bands, the plate lead should have an 8 mhy. R.F. choke and the grid a 5-meter choke. These are not necessary for ordinary usage, however. The circuit works best with 90 to 100 V. on the screen-grid.

Edw. Lovick, Jr.

Triplet Model 1500 Tube Tester. This tester would show "short" with no tube in it, and also the meter would indicate when making "short" test on diodes of duo-type tubes. After considerable trouble-hunting, we found that metal particles had worn off the selector switch contacts, causing leakage across contacts. The remedy is to blow out these metal particles and lubricate with Grafoline contact lubricant.

Firestone-Stewart-Warner 1936 Auto Radio Sets. If one of these sets suddenly stops playing,

but the vibrator still functions and the battery drain is 15 or 20 A., the 0.01-mf. condenser across the power transformer is shorted. It is necessary to remove the transformer cover to effect a repair—by replacing with a 1,600-V., 0.01-mf. condenser.

KENNETH M. CHURCHILL

Zenith Model 666 Auto Radio. This set generally comes in with the complaint: "it is noisy while going over rough roads—the noise not being caused by the motor—later, the set becomes intermittent." Remove the cover from the set and replace the 3 wires on the top of the variable condenser unit with some very flexible wire. If the set lacks sufficient pep and volume, replace the type 6C6 tube although it tests perfect, for the oscillator section cannot be easily tested.

PAUL WALLACE

Philco 91. Several sets of this model were reported to have cut off dead, only to be OK after the power switch was turned on and off a few times. The trouble was found in the 0.01-mf. A.F. coupling condensers, housed in bakelite cases, which are used between the 2nd-Det.—Det. Rect., and the 1st and 2nd A.F. The first one does not go as often as the one between the 1st and 2nd A.F., but it is a good thing to replace

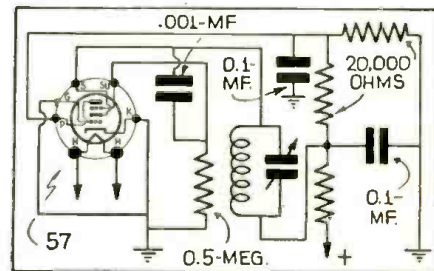

Fig. 1

both with 600 V. tubulars of 0.01-mf. capacity.

J. O. S. HUNTER,

Kingston,

Prince Edward Island, Canada.

Stromberg-Carlson 160-L or 160-P. Background "hiss" or "rushing noise", when encountered in a 160-L or 160-P receiver, can usually be cleared by replacing the 6A8 modulator tube.

Incidentally, the 6A8 tube removed from a 160 can frequently be employed with full satisfaction in a Stromberg-Carlson 125, 130, 140, 145, 150 or 180 receiver. Thus, clearing noise in a 160 becomes simply a matter of swapping 6A3 tubes with another Stromberg-Carlson.

The trouble is thought to be due to a defective weld in the "2nd" grid, occurring in a small percentage of 6A8 tubes. It does not show up on tube checkers, and causes no noise where the tube is used with potential on this grid.

STROMBERG-CARLSON Solder Nuggets

Wells-Gardner Series 5D. If it seems impossible to align this set on short waves, check for defective 1st-detector short-wave trimmer condenser. Low volume may be caused by a 42 power tube plate-to-cathode bypass condenser (C26) or (C21) cathode bypass condenser having opened or shorted. Replace with one of higher value.

SPARTON SELECTRONNE RECEIVERS MODELS 1068 AND 1068X

10-tube superheterodyne; three bands; push-button (Selectronne) tuning; automatic frequency control; automatic volume control; discriminator circuit; "vis-o-glow" tuning indicator.

(See Data Sheet 218 for schematic diagram and operating voltages)

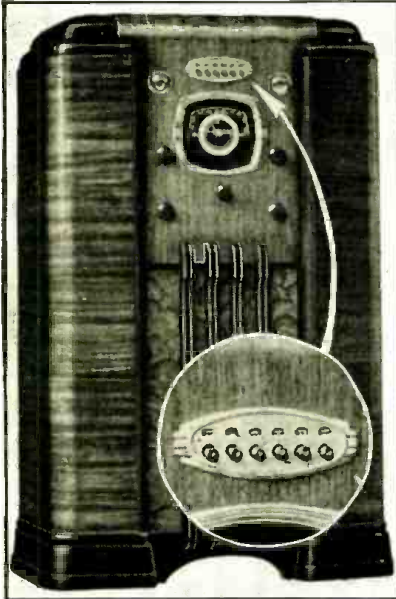

Sparton model 1068 Selectronne receiver, a new 1938 model using latest push-button tuning. The photo at extreme right of this page is a rear view of the locations of the trimmers for the tuning buttons shown in the above front view of this receiver.

The 6 buttons of the Selectronne are arranged in 3 groups according to frequency limits—542 to 900 kc., 700 to 1,300 kc., and 1,000 to 1,500 kc. The 6 taps corresponding to the desired stations must be arranged in the steel plate so that each station frequency will be included in the proper frequency group. To align, push in the Selectronne button which corresponds to the desired station and adjust for maximum response as indicated by the Viso-Glo tube; the aligning sequence is: (1) oscillator trimmer (center hole), (2) first R.F. trimmer (button hole), and (3) antenna trimmer (top hole). (The Viso-Glo tube and socket may be removed from its clamp and the tube turned toward the back of the cabinet for observation.) Adjust Selectronne trimmers for equal shaded area with band switch knob either in or out. During above operations the 6H6G discriminator is removed from chassis. In the event that all 6 Selectronne buttons become depressed through improper manipulation they may be

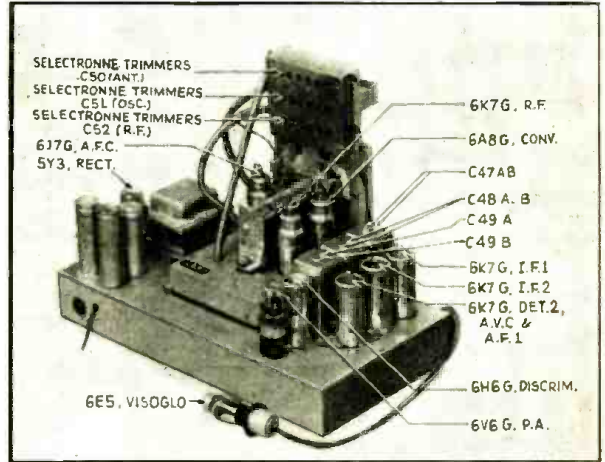

released by applying a slight pressure of the fingers under the latching band which runs across the framework in front of the trimmer box. Care should be taken to prevent loosening the Selectronne adjusting screws to the point where they may become disengaged.

The above-mentioned latching bar is seen in the photograph of the locations of the Selectronne trimmers. This latching bar, on the back of the block that carries the Selectronne trimmers, is in direct line with the arrow that points to Selectronne trimmers C51 (osc.); a corner of the latching bar extends past the rear right edge of the trimmer panel.

Viso-Glo tube in socket
AFC Switch "OFF"

ALIGNMENT

OPERATION	ALIGNMENT OF	GENERATOR CONNECTED TO	DUMMY ANTENNA	GENERATOR FREQUENCY	BAND SWITCH SETTING	TUNING COND. SETTING	TRIMMER	REMARKS
1	I.F.	Conv. Grid	.1 mf.	456	BC	Open	C47 A,B	1st I.F. Trans.
							C48 A,B	2nd I.F. Trans.
							C48 A	3rd I.F. (Pri.)
2	Discrim.	Conv. Grid	.1 mf.	456	BC	Open	C49 B	Adjust to minimum
3	Broadcast Band	Ant.	200 muf.	1500	BC	1500	C8 Osc.	
							C5 RF	
							C2 Ant.	
4		Ant.	200 muf.	600	BC	600	C11 Pad	
5	(Repeat operation 3)							
6	(Check calibration and sensitivity 1500 KC, 900 KC and 600 KC) *							
7	1st Short-Wave	Ant.	100 ohm 200 muf. series	6 MC.	1st S.W.	6 MC.	C9 Osc.	
							C6 RF	
							C3 Ant.	
8		Ant.	200 muf.	1.95 MC.	1st S.W.	1.95 MC.	C12 Pad	
9	(Repeat operation 7)							
10	(Check calibration and sensitivity at 6 MC. and 1.95 MC.)							
11	2nd Short-Wave Band	Ant.	100 ohm 200 muf. series	18 MC.	2nd S.W.	18 MC.	C10 Osc.	Rock dial slightly while adjusting
							C7 R.F.	
							C4 Ant.	
12		Ant.		6 MC.	2nd S.W.	6 MC.	C13 Pad	
13	(Repeat operation 11)							
14	(Check calibration and sensitivity at 18 MC. and 6 MC.)							
15	(Repeat operations 1 to 14 inclusive)							

* Check AFC by connecting generator to converter grid cap and tuning generator and receiver to 1500 KC. Note output meter reading with AFC switch "off". Switch AFC "on" and if output changes appreciably, touch up discriminator trimmer until there is no change in sensitivity.

SPARTON SELECTIONNE RECEIVERS MODELS 1068 AND 1068X

10-tube superheterodyne; three bands; push-button (Selectionne) tuning; automatic frequency control; automatic volume control; discriminator circuit; "vis-o-glow" tuning indicator.

(See Data Sheet 217 for alignment chart and chassis layout)

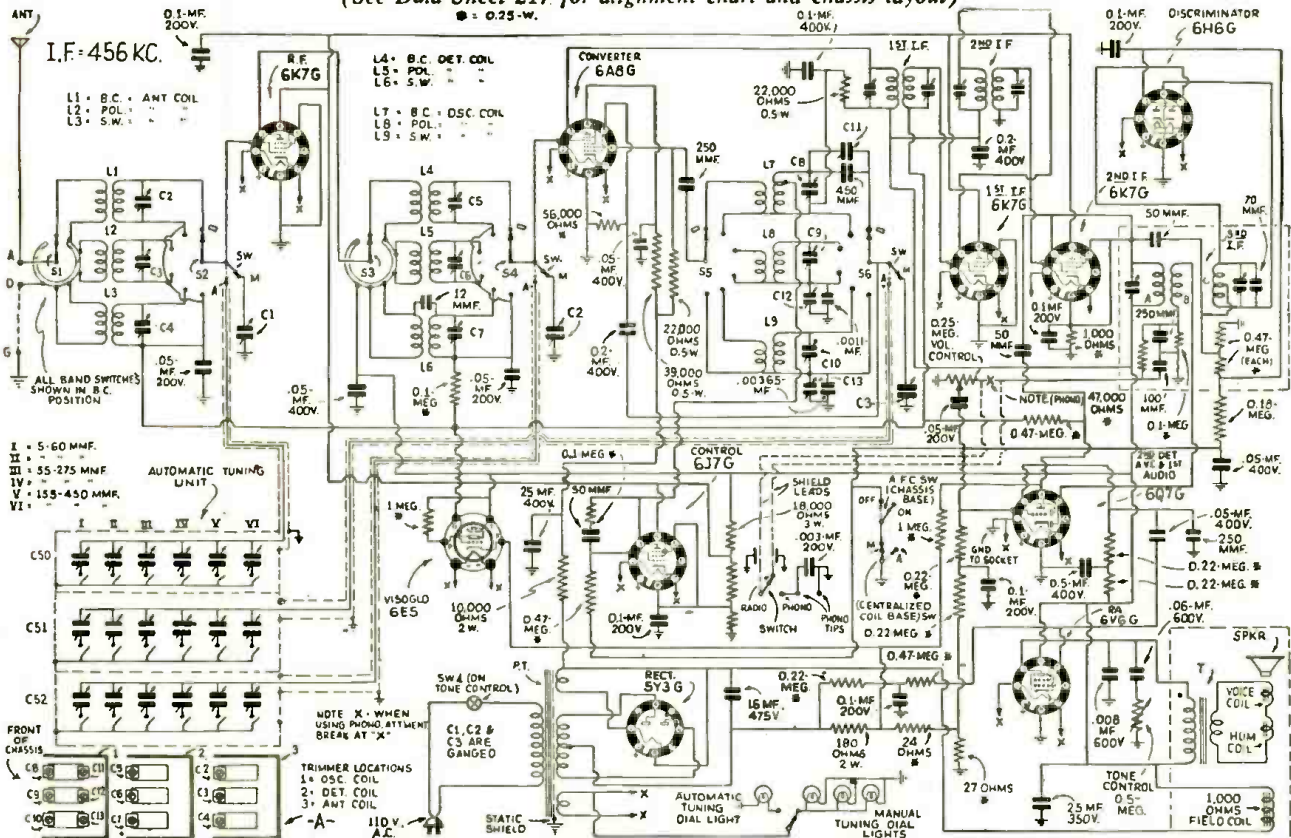

Schematic diagram of the Sparton model 1068 and 1068X. The same circuit is used in the models 1078 and 1078X.

VOLTAGE CHART

Line Voltage: 115 volts

Position of Volume Control: Full with Antenna Disconnected

Tube	Function	Voltage of Socket Prongs to Gnd. (See Prong Nos. on Schematic Diagram)								Grid Cap
		No. 1	No. 2	No. 3	No. 4	No. 5	No. 6	No. 7	No. 8	
6K7G	R.F.	0	0	300	75	0	-	6.3	0	.2
6A8G	Converter	0	0	300	91	5.5	135	6.3	0	.2
6K7G	I.F.	0	0	300	75	0	-	6.3	0	2.6
6K7G	2nd I.F.	0	0	300	75	4	-	6.3	4.1	0
6H6G	Discriminator	0	0	.5	0	.5	-	6.3	0	-
6J7G	A.F.C.	0	0	300	85	4.5	-	6.3	4.4	0
6Q7G	2nd Det. AVC-1st audio	0	0	100	.2	.1	-	6.3	0	0
6V6G	P.A.	0	0	275	290	.5	.6	6.3	0	-
5Y3G	Rect.	-	350	-	350	-	350	-	350	-
6E5	Viso-Glo	6.5	50	3	280	4	0	-	-	-

Notes: Voltage readings are for schematic diagram on back of sheet. Allow 15% + or - on all measurements. Always use meter scale which will give greatest deflection within scale limits. All measurements made with 1000 ohms per volt voltmeter.

OFFICIAL RADIO SERVICE MEN'S ASSOCIATION, INC.

MEMBERS' FORUM

A department devoted to members and those interested in the Official Radio Service Men's Association. For mutual benefit, contribute *your* kinks, gossip and notes of interest to Service Men, or others interested in servicing.

DOESN'T WORRY ABOUT "GYPS"

RADIO-CRAFT, ORSMA, Dept.:

I have long been an ardent reader of your section in *Radio-Craft*, but have failed to join your Association. May I say that you have one of the finest ideas and organizations in the United States?

Recently, I read a published letter of one Service Man complaining about conditions and swindlers—I don't recall the word he called them—but they are present in every town, city and what have you. We all have to contend with them. They don't worry me so much as they did when I first started in. If they work a set over, I get it myself in a week or two!

When I finished radio school I went to work for a radio factory. Then the slack season set in and I found myself almost without a job, so I started my own service business.

Well, I decided I could get by with just an analyzer and a few tools (having aligned and serviced in the factory with just a screwdriver). But I found the other Service Men had the same equipment and could wreck a set better than I could put it together with my small amount of equipment.

Let me tell you here and now—these "flunkies" aren't fooling anyone but themselves now. With my equipment they don't stand a chance. I almost have more business than I can handle. I don't care if my competitors would and do put in a volume control for \$1. I know what kind it is (one out of a salvage set or factory reject), so the customer will sooner or later come to me and complain—whereupon I get the job.

Advertising is the one way the "gyp" Service Man can be licked—display of R.M.S. and ORSMA emblems, and such, in newspapers and throughout the service shop will help bring trade. Also the constant preaching and teaching of one's customers that such organizations and their members are the only ones, and that display of such organization emblems would mean, of course, high quality service.

Will you please send me an application blank and literature on your organization?

RONALD ULMER,
Purcell, Okla.

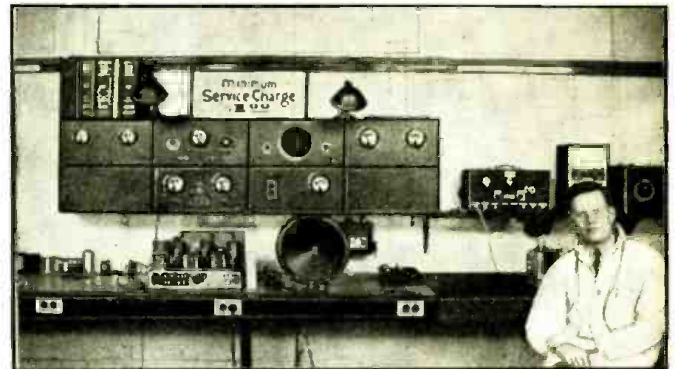

Service Man William A. Hayward of Chicago is the proud owner of this "going" service shop; and a bright young man he is, too! In a contest for Service Men held at the recent National Radio Parts Show at Chicago, Mr. Hayward took 1st place in guessing the total capacity of all the condensers mounted on the display board of the Sprague Products Corp. He estimated a total of 1,200 mf. as compared to the actual total of 1,188,322 mf. Nice going, "Bill."

WANTS TO CONTACT OTHER ORSMA MEMBERS

RADIO-CRAFT, ORSMA, Dept.:

I receive a copy of your magazine every month and I think it's the best radio magazine for its price.

(Continued on page 359)

RADIO WITTIQUIZ

(28) When a radio man says that a radio set has lots of "bugs" in it he means—

- (a) There are lots of electrons crawling around in the set. (b) It is infested with insects. (c) There are unsolved troubles in the set. (d) There are lots of dizzy comedians or half-wit announcers broadcasting.

CARL J. SPEHR

(29) Parallax is—

- (a) A laxative. (b) A rubber cement. (c) A method of testing eyes. (d) A device on a camera to focus it. (e) An aberration in reading caused by perspective.

P. M. LAMBERTON, JR.

(30) Any "ham" knows that his monitor is a device to—

- (a) Check his signal frequency. (b) Regulate his code speed. (c) Warn him of too high a voltage being used. (d) Prevent interference.

EARL ROBERTS

(31) Nichrome is—

- (a) The radio center of the U.S.S.R. (b) A gas which produces a reddish glow when ionized. (c) A rare element used in radio tube filaments. (d) An alloy of nickel, chromium and iron having high resistivity and able to withstand high temperature.

ELDON ADWAL,
San Fernando, Trinidad, B.W.I.

(32) If you were sent to find a padder you

would look for—

- (a) A small rubber mallet used for striking the chassis in checking for "intermittents." (b) A high-voltage insulating material. (c) A small adjustable condenser. (d) A rubber cushion for floating chassis or variable condenser. (e) A machine for stuffing mattresses.

R. H. MINER

(33) A transformer is—

- (a) A wig. (b) A device for transferring A.C. from one circuit to another by means of electromagnetic induction. (c) A name for a person who betrays a confidence. (d) A beauty parlor operator. (e) A device that will increase or decrease the potential of an alternating current applied to one of its windings.

S. WILBERT STONE,
Collingwood, Ont., Canada.

(34) A microphone is—

- (a) Used to detect the presence of micro-waves. (b) A new type of telephone for people whose ears are not set back as far as the average person's. (c) A device for converting sound waves into electrical impulses. (d) A radio tube with loose elements. (e) A new telephone for children.

W. W. LANDFORD

(35) When we say "fading" we refer to—

- (a) A term used in dice games. (b) The gradual decrease of a received signal. (c) The loss of color, as from washing. (d) A colloquial

term indicating loss of youth.

WAYNE FOXWORTHY

(36) By baffle board we mean—

- (a) The Board of Regents. (b) A piece of material used to enhance the reproduction of low frequencies. (c) An "ouija" board. (d) A projecting piece that hinders easy placing of chassis in cabinet. (e) A mystery story that puts one to sleep.

IRVING SCHLAM

(37) Counterpoise has been defined as—

- (a) A wire or other device that acts as a second plate of condenser with aerial wire and air. (b) A weight used to balance another weight. (c) Irritability, fussiness, the opposite of poise. (d) A waitress leaning gracefully over the counter. (e) A term used in radio musical composition.

S. O. HARRIES,
Williams Lake, B. C.

(38) Anyone with an interest in radio knows that a microphone jack is—

- (a) A popular radio announcer. (b) An instrument for raising or lowering a microphone. (c) A contrivance to receive a plug to which is wired a microphone. (d) Money received for radio broadcasts.

LESTER ROGERS,
Pleasantville, Lunenburg Co.
Nova Scotia.

(Continued on page 359)

AMAZING VALUE VOLT-OHM-MILLIAMMETER

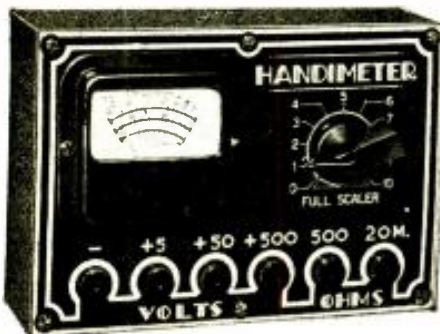

WE are making the vastest production of a volt-ohm-milliammeter in the history of radio and because of this tremendous quantity production we are able to offer at an incredibly low price an instrument fine in appearance and performance. This is our new HANDIMETER and it performs the following measurements:

0-5 Volts D.C. 0-50 Volts D.C.
0-500 Ohms 0-20,000 Ohms.

The device is a perfect continuity tester, besides, and also may be used for determination of direct currents up to 20 milliamperes.

The voltages and resistances of unknowns are direct-reading on a square-type meter of exquisite design. There are, besides the meter, a zero ohms adjuster, called the Full Scaler; also six binding posts, one black for common connection, three reds for the three voltage ranges, and two reds for the two resistance ranges.

Outstanding on Appearance and Performance!

AMONG inexpensive volt-ohm-milliammeters the HANDIMETER is tops because (1) higher voltages may be measured, 500 volts being an unusual maximum for small instruments of this type; (2), there are two resistance scales, instead of only one, and both are controlled by the Full Scaler, no such adjustment for accuracy being present in other instruments in this class; and (3), the low ohms scale is a novelty to such instruments, and permits a wide extension of use, including checking shorts and opens in radio-frequency and intermediate-frequency coils, as well as measurements down to a few ohms.

The meter itself, a new model, is in a handsome housing. Moreover, the panel itself is etched metal, with all the required designations clearly printed and conveniently grouped. The HANDIMETER is supplied complete with three self-contained, readily renewable, inexpensive dry batteries (normal life of batteries 3 mos.), and a pair of test leads. Order a HANDIMETER to-day. Shipping weight, 3 lbs. Net price.....

\$4¹⁰

MULTIVIBRATOR



NEW to the servicing industry, the MULTIVIBRATOR opens fresh fields for perfect servicing. The first instrument of its kind offered to servicemen, the MULTIVIBRATOR is a generator that produces all frequencies from 100 kc to 20 mc, without any switching, and therefore permits testing all-wave receivers for presence of dead spots. Many sets have such tuning "holes," and once the blanks are found they are easily corrected, and thus customers are delighted with the new life put into their receivers. The MULTIVIBRATOR is the equivalent of having always available every frequency of every station on the air. It may also be used as a station finder. It works on 90-130 volts a.c. or d.c. (a.c. of any commercial frequency), and is equipped with an output attenuator calibrated in decibels down (0 to minus 20 db). Supplied complete with two 6A7 tubes. Order a MULTIVIBRATOR to-day. Shipping weight, 5 lbs. Has carrying handle. Net price

\$5⁹⁵

THE ALLMETER — 1,000 Ohms Per Volt — 23 Instruments — \$10⁴⁰

THE Allmeter, a 1,000-ohms-per-volt d'Arsonval instrument, instead of being just a volt-ohm-milliammeter, is such an instrument, plus a.c. readings for voltages and currents, also accurately measuring very low resistance, from below one ohm, also high resistance, capacity, henries and decibels, comprising 22 instruments in one.

All eleven different classifications of services performed by the ALLMETER, as tabulated at right, comprising the equivalent of 22 instruments, meet the high requirements of modern servicing. The instruments are carefully made, calibrated and adjusted at our large factory, and are ruggedly built for long life. Besides the usual circuit testing and measurements that a high-grade volt-ohm-milliammeter affords, this instrument enables you to make those other tests you have long wanted to be able to make, so you can tell whether condensers are good or not, what their capacity is, and also check the condition and inductance of audio coils, including B filter chokes, and take instantaneous decibel readings of receivers and amplifiers. In other words, the ALLMETER enables you to do a first-class servicing job. It has a carrying handle.



Shipping Weight, 8 lbs.

- 1—A-C Currents, 15-150-750 ma. This extremely valuable service is practically never afforded by multimeter instruments. Instruments, 3.
- 2—A-C Volts, 15-150-750 volts. Affords also output meter service. Instruments, 3.
- 3—CAPACITY, .01-50 mfd., all condensers, including electrolytics. Instruments, 1.
- 4—5-1,000 Henries, coil loaded or not. Instruments, 1.
- 5—LOW ohms, .03-500 ohms. Extremely valuable. Instruments, 1.
- 6—HIGH ohms, to 0.5 meg., covering all practical values. Instruments, 1.
- 7—D-C Volts, 15-150-750 volts. Simplified scale uses same calibration as for a.c. Instruments, 3.
- 8—D-C Currents, 15-150-750 ma. The same scale simplification. Instruments, 3.
- 9—Decibels, —12 to +10, also foregoing plus 20. Instruments, 2.
- 10—Vacuum-tube voltmeter, 0-15-150-750 volts. Instruments, 3.
- 11—Short tester, including condensers. Instruments, 1.
- 12—Milliammeter, 0-1.

GENEMETER

WITH VARIABLE AUDIO FREQUENCIES



OUR superlative signal generator, direct reading fundamental frequencies, 100 kc. to 22 mc., and direct reading also to 100 mc., has modulation on-off-service, with bandspread audio frequencies 25-10,000 cycles. Audio, in three bands, is saw-tooth wave and useful for oscilloscope sweep.

1. Direct reading in frequencies, 100 kc —22 mc., in five bands, all fundamentals, by front-panel switching. Ultra band by harmonics to 105 mc. also direct reading.
2. Direct reading in frequencies, 25—10,000 cycles, in three bands, all fundamentals, by front-panel switching.
3. R.F. and A.F. outputs independently obtainable alone, or with A.F. (any frequency) modulating R.F.
4. Output meter for connection across primary of receivers' output transformer for peaking with modulation "on."
5. R.F. is subject to attenuation, and oscillation leakage is minimum.
6. Condenser and other leakages tested to 100 megohms.
7. Main dial protracted on 7/8" diameter, used full size, with precision pointer (no parallax), and 4-to-1 vernier planetary drive.
8. All services on 90-130 volts a.c. or d.c.

Shipping weight 10 lbs.

\$14⁴⁰

Complete with Four Tubes

TUBE TESTER \$10⁴⁰

ONE of the requirements of every service bench is a good Tube Tester, one that is rugged, dependable and gives a convincing test. Our Tube Tester uses the well-established emission test method for determining the condition of a tube, so that when the rapid test is conveniently completed you know for a certainty just how good or bad the tube is. Light in weight, as compact as such a comprehensive device can be, the Tube Tester may be adapted to bench or portable use.

FEATURES

- * Tests all 4, 5, 6, 7, 7L and octal base tubes.
- * Tests all Diodes, Triodes, Pentodes and Tetrode receiving tubes, as well as many transmitting types.
- * Separate Neon Test for leakage or shorts between elements.
- * English reading meter, with "BAD-7-GOOD" scale.
- * Minimum number of adjustments, without impairing efficiency or accuracy of test.
- * Rugged, fool-proof construction. Built for a lifetime of use.



SUPERIOR INSTRUMENTS CO., Dept. RC-12 136 LIBERTY ST., N. Y. City

Please Say That You Saw It in RADIO-CRAFT

HOW TO BUILD THE "ALARM CLOCK" WALL-RADIO SET

(Continued from page 351)

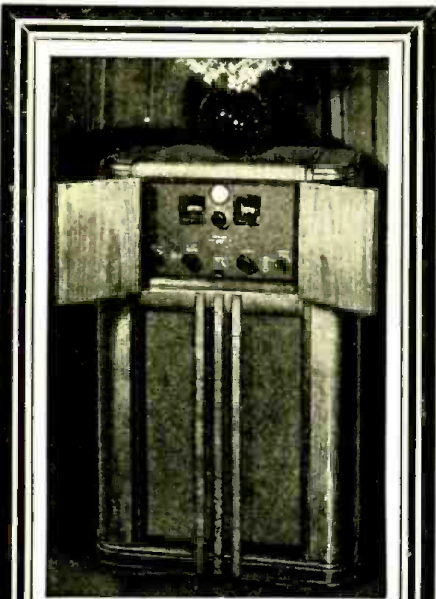

"SUPER-PRO" CONSOLE A HIT!

THE new Hammarlund "Super-Pro" professional receiver console model—presenting professional efficiency, stirring acoustical reproduction, and a distinctive console—though announced only a few weeks ago, has already become the talk of the country! The brilliant low and high audio frequencies, characteristic of real high fidelity, are now completely available with this new type console model with its wide range heavy duty 15" speaker, inclosed in a specially developed sealed sound chamber. With this new type sound chamber, the "boominess" or so-called cabinet resonance, is completely eliminated. In addition, the range of the loud speaker is extended approximately an octave.

The receiver itself, affords the marked superior efficiency the professional demands for his critical measurement and air patrol work. Among its outstanding features are: 2 stages of R.F. on all bands; fractional microvolt sensitivity; absolute image rejection on all bands; electrical band spread; exclusive cam operated knife switch (noiseless and trouble-free); electrostatically shielded input coils; calibrated band width (3 to 16 kc.); sensitivity and audio gain controls; phone jack; stainless steel full floating bearings; silver plated switch and condenser contact; models for 7½ to 240, 15 to 560, and 15 to 2000 meters, etc.

For guaranteed superior results install this new Hammarlund "Super-Pro" console model. Write department RC-12 for further details. Mail coupon below.

HAMMARLUND MFG. CO., INC.
424-438 W. 33 St., N. Y. City

Please mail me "Super-Pro" console bulletin.

Name

Address

City State



¼-in. thick. The radio set compartment has no back panel so that the chassis can very conveniently be slipped in and out for servicing. Two speaker grilles have been cut, one in each of the side panels, the extra one serving both to ventilate the set chamber and to relieve the pressure of the back sound waves of the speaker, thereby preventing boominess or "cavity resonance." Towards the rear of the first shelf will be noticed a long ½-in.-wide vent, strategically placed to ventilate the hot metal tubes (and those tubes *do* get hot!). It serves its purpose excellently provided the shelf is not packed too full with books or other bulky objects. Placement of the single mounting hole is quite important. It should be triangular-shaped and must be cut *exactly* in the center if the completed cabinet with its heavy chassis and speaker are to hang perfectly straight. If not successful in this operation and the cabinet does hang at an angle, merely drill a small hole in lower center of the back panel and drive a nail or wood-screw into the wall. Note that the front panel is set-in about ¾-in. so that the knobs of the receiver will be flush with the front edges of the cabinet.

THE INTERCOMMUNICATOR

The ease with which a radio set (any set having at least 2 stages of A.F. amplification) can be made to function as an intercommunicating system is quite remarkable. The necessary equipment comprises merely an extra speaker, a "radio-talk-listen" selector switch, a length of 4-conductor cable, a voice coil-to-grid input transformer and a simple buzzing system. Of course more elaborate systems than this may be installed by the individual constructor but the purpose served will be the same... intercommunication. Refinements in design will naturally bring added conveniences such as being able to talk from either end instantly, without first signaling the opposite end, and turning the set on or off from either end, but we'll leave these to the individual builder.

Figure 3 shows (in dotted lines) how the components of the system are connected to the receiver circuit. Each speaker is of the permanent-magnet dynamic type and acts alternately as microphone and loudspeaker by merely throwing the selector switch from its normal "radio" position to either "talk" or "listen." The system functions as follows:

We'll assume that the set is turned on and is receiving a radio program. (The remote speaker, incidentally, also hears radio programs and thus acts as an extension speaker.) The party at the receiver we'll call "station No. 1." This is the control station. The party at the remote speaker we'll call "station No. 2." In order for station No. 1 to call station 2, he need but flip the toggle switch to "silent" (this shorts the antenna to ground thereby silencing the radio program) and then turn the "radio-talk-listen" switch (which is normally set to "radio") to "talk." This operation automatically cuts off the radio program and "converts" his loudspeaker into a microphone. To call station No. 1 station No. 2 has to signal by means of the buzzer whereupon station No. 1 turns his switch to "talk," says "O.K. come in" and then resets the switch to "listen." The person at the remote station has no control over the system.

THE AUTOMATIC TIME CLOCK

The time clock which plays such a major role in the operation of this set is a self-starting movement which can be obtained in any electrical appliance store. Around the periphery of the clock dial are 48 equally-spaced metal "tabs" which can be pulled in and out for a short distance. (See Fig. 4A.) These tabs control the operation of a switch which is built into the mechanism as an integral part of the clock (Sw.3 in Fig. 4B) and which in turn controls the current in the double outlet tap into which are plugged the radio set and/or any other electrical appliance. Shunted across the internal clock switch is a toggle switch (Sw.1 in Fig. 4, A and B) which is mounted, externally, directly above the clock. This affords manual operation of all appliances normally controlled by the time clock. Figure 4A shows, pictorially, how the time clock and the associated apparatus are interconnected. Figure 4B shows all these connections schematically.

Now let's suppose we wish to be awakened at 6:00 in the morning by the radio receiver. We turn the toggle switch (Sw.1) to M (manual), turn the set "on" and tune to a station which we know definitely is on the air at that early hour in the morning. The volume control is then set to a point sufficiently loud to awaken us. Now, with the radio receiver all set, turn it off by flipping the same toggle switch back to A (automatic). Don't touch the controls of the set anymore. Now pull out the "tab" (around the edge of the clock dial) which is directly behind the figure 6. In the morning, promptly at 6 o'clock, the radio set will come on, play for 15 minutes and then shut off again. If we wish it to remain on we merely pull out (the night before when we are setting the "works") additional "tabs" adjacent to the one for 6 o'clock. Each tab controls 15 minutes of time; thus if 2 tabs are pulled out the radio will play for a half-hour and then shut itself off, and so on. Thus we have an "Alarmclock" Radio Set.

Inside the cabinet are mounted a bell and bell-ringing transformer which may be substituted for the radio set. Figure 4, A and B, show how they are connected. Any electrical appliance may be plugged into the double electric outlet controlled by the clock and from then on be automatically turned on and/or off at any predetermined time. There are any number of other tasks which this arrangement can be made to perform—tasks which the constructor will probably think of while he's building the "Alarm-clock" Wall-Radio Set.

Incidentally, a tone control has been added to the set since Part 1 was written. This consists of a 0.02-mf. fixed condenser in series with a 0.1-meg. potentiometer. They are shown in heavy lines in Fig. 3.

LIST OF PARTS

- One Cinnaudagraph 5-in. "permag" dynamic speaker;
 - One 3-pole, 3-contact switch;
 - *One voice coil-to-grid input transformer;
 - One buzzing system;
 - *One "Telechron" time clock;
 - A single length of 4-conductor cable.
- *Names of manufacturers will be supplied upon receipt of a stamped and self-addressed envelope.

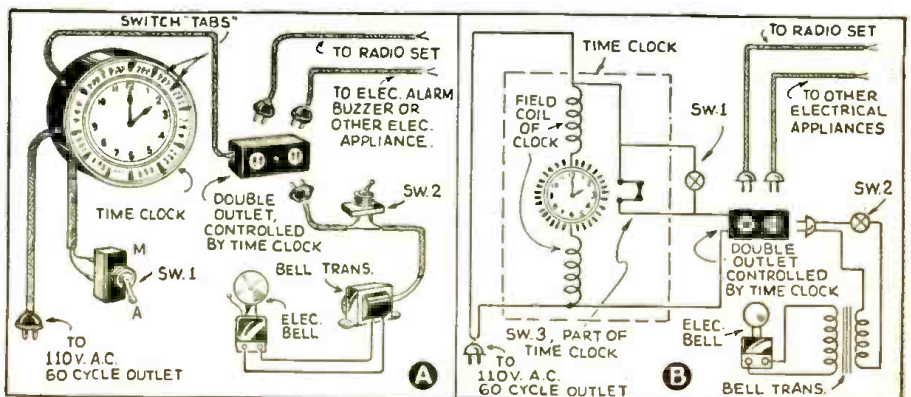

Fig. 4A. The pictorial (A) and schematic (B) diagrams showing how the time clock is connected to control an electric outlet and hence any electrical instrument plugged into it.

Please Say That You Saw It in RADIO-CRAFT

NEW CIRCUITS IN MODERN RADIO RECEIVERS

(Continued from page 345)

that a considerable I.F. signal fluctuation is conducted through the feedback coil. While the oscillator coils are not tuned to the I.F. there is adequate I.F. voltage developed across them to provide added gain through feedback. The I.F. circuits are stabilized and broadened by the use of "filled cores".

(5) Suppressor-Grid Regeneration

Philco Model 38-60 Code 125. Stabilized regeneration is obtained in the small Philco receivers by using the suppressor-grid as the feedback coupling agent as in Fig. 1E. The suppressor-grid of the I.F. tube is grounded through a small coil coupled to the control-grid coil in such a way as to produce some regeneration. This is possible through the use of "filled core" I.F. transformers which introduce sufficient loss at resonance to provide stability. Its advantage is increased gain of the receiver without using additional stages. The amount of regeneration is not sufficient to impair the practical fidelity characteristics.

(6) Direct Coupling To Discriminator Input

RCA Model 812K. As will be observed by reference to Fig. 1F, the I.F. is induced into one of 2 coils in series and the auxiliary double winding of the discriminator is coupled to the other. The top of this intermediate or "link" circuit is directly attached to the center of the secondary auxiliary winding. While D.C. flows in the link circuit, capacity coupling to the discriminator input secondary is avoided; as well as the need for a choke coil.

ORSMA MEMBERS' FORUM

(Continued from page 356)

Some extra special subjects I enjoy are: Operating Notes, Members' Forum, Radio Service Data Sheets, and Latest Radio Equipment.

I'm 19 years old and I work in a radio service department store in Oakland, California, during the day and do radio work during my spare time at home.

I would like to exchange photographs with other members so we could get acquainted.

ROBERT W. METKE,
Hayward, Calif.

Thanks for the bouquet, "Bob." Most Service Men pick the same departments you do. Incidentally, mail addressed to "Bob" will be forwarded by Radio-Craft.

RADIO WITTIQUIZ

(Continued from page 356)

Answers

- | | | |
|-------|-------|-------|
| (28c) | (32c) | (35b) |
| (29c) | (33b) | (36h) |
| (30a) | (34c) | (37a) |
| (31d) | | (38c) |

Contest Rules

- (1) An award of a 1-year subscription to Radio-Craft will be given to each person who submits a WITTIQUIZ that the Editors consider suitable for publication in Radio-Craft.
- (2) WITTIQUIZZES should preferably be typed; use only one side of paper.
- (3) Submit as many WITTIQUIZZES as you care to—the more you submit the more chance you have of winning—but each should be good.
- (4) Each WITTIQUIZ must incorporate humorous elements, and must be based on some term used in radio, public address or electronics.
- (5) All answers must be grouped, by question number and correct-answer letter, on a separate sheet of paper.
- (6) All contributions become the property of Radio-Craft. No contributions can be returned.
- (7) This contest is not open to Radio-Craft employees or their relatives.
- (8) The contest for a given month closes on the 15th of the 3rd month preceding magazine issue date. (For instance, contributions to February, 1938, Radio-Craft, on the newsstands about Jan. 1, must be received at Radio-Craft editorial offices not later than Nov. 15th, 1937.)

TRADE *your* AUTOGRAPH for this GOLD-MINE



THAT'S NO ORDINARY HEAD-LINE, MISTER, I KNOW—I TOOK 'EM AT THEIR WORD AND SWAPPED MY NAME FOR WHAT TURNED OUT TO BE THE SWELLEST RADIO CATALOG I'VE EVER SEEN—



PUBLIC ADDRESS EQUIPMENT

Page after page of the world's greatest line of amplifiers and public address systems. There's money in this new field and the FREE catalog shows you how to make it. Whether you rent, sell or install, this is the book for you.

LAFAYETTE RADIOS

35 pages of sets, showing 70 models. Priced so low, that the "extra set" need no longer be just a hope. Study the LAFAYETTE line in the FREE catalog and you'll learn what real radio value is. Prices range from 8.75 to 99.50. 30 day free trial in your own home.

"HAM" RECEIVERS

Every nationally advertised line of amateur equipment—receivers and parts. They're all in this FREE WHOLESALE Catalog and at prices that will astound you. Consult with our engineering staff for special "rigs". No obligation, of course.

TEST INSTRUMENTS

You servicemen will find this part of the catalog particularly valuable. The finest in set testers, tube checkers, oscilloscopes, etc. at prices that will make you sit up and take notice.

EASY TIME PAYMENT PLAN

Get your P.A. equipment, LAFAYETTE radios, "Ham" receivers, Test instruments on Wholesale's Easy Payment Plan, outlined in the FREE Catalog.

TAKE THE GUESSWORK OUT OF XMAS SHOPPING WITH THIS New FREE CATALOG

Do your Xmas shopping from Wholesale's special Xmas catalog. 40 pages of "extra value" gift buys featuring nationally advertised electric trains, home appliances, toys.

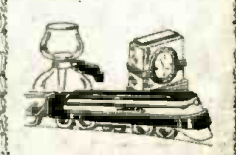

CLIP COUPON NOW FOR BOTH CATALOGS — 220 PAGES OF ASTOUNDING VALUES

WHOLESALE RADIO SERVICE CO., INC.
NEW YORK, N.Y. CHICAGO, ILL. ATLANTA, GA.
100 SIXTH AVENUE 901 W. JACKSON BLVD. 430 W. PEACHTREE ST., N.W.
BOSTON, MASS. BRONX, N.Y. NEWARK, N.J. JAMAICA, L. I.

WHOLESALE RADIO SERVICE CO., INC.
100 SIXTH AVENUE, NEW YORK, N. Y.

Rush FREE 1938 Catalog No. 69-3M7
Rush FREE Xmas Catalog No. 70-3M7

NAME _____
ADDRESS _____
CITY _____ STATE _____

they're
FREE

PASTE COUPON ON PENNY POST CARD

Please Say That You Saw It in RADIO-CRAFT

TAKE THE EASY WAY TO LEARN RADIO

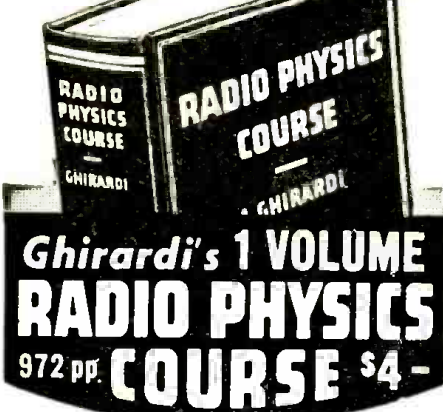

You, too, can pick up RADIO quickly—if you will let Ghirardi help you. In almost no time at all you'll completely master the subject, because Ghirardi's 972-page home-study RADIO PHYSICS COURSE is such easy reading, so simple, so absorbing, and so exciting, that you won't lay it down from the time you start with simple electrical theory to where you wind up with television under your belt! Sure, Ghirardi gives you "the whole works"—everything you want to know about RADIO, ELECTRICITY, SOUND—and even TELEVISION! It's as simple as A B C. That's why more radio schools and students use it than any other radio book in the world. They say it's the best there is—at any price! Why, the 506 illustrations alone are worth much more than the amazingly low price of only \$4 for the whole book! When are you going to start? Don't put it off—get going—learn RADIO NOW from the one great book! Mail the Coupon below—AT ONCE! Remember every penny of your money back if not fully satisfied!

WHAT YOU WILL LEARN FROM THIS BOOK!

- Sound, Speech and Music
- Electrons
- Electric Current
- Electric Units and Circuits
- Resistance
- Ohm's Law
- Batteries
- Magnetism
- Electromagnetism
- Transformers
- Inductance
- Condensers
- Alternating Current Circuits
- Filters
- Electrical Measuring Instruments
- Radio Waves
- Radiations
- Broadcast Stations
- Receiving Equipment
- Vacuum Tubes
- Radio and Audio Frequency Amplification
- Superheterodynes
- Local Speakers
- Batteries
- Operas and Receivers
- Power Supply Units
- Electric Receivers
- Automobile and Aircraft Receivers
- Photograph Pickups
- P. A. Systems
- Short-Wave Receivers
- Photoelectric Cells
- Television
- Antennas and Grounds
- Testing and Servicing Receivers
- Sound Motion Pictures
- Appendices
- 816 Review Questions
- AND LOTS MORE!

Snip this Coupon out! -MAIL IT NOW!

Send me **RADIO & TECHNICAL PUBL. CO.** Dept. AC-12, 45 Astor Place, New York. Please send me **1** copy of **RADIO PHYSICS COURSE** on one postpaid. (Design \$4.50) Send me a free circular describing this book.

Name _____
Address _____

MONEY-BACK GUARANTEE!

IDEAL XMAS GIFT!

Radio-Electrical EXPERIMENTS

25-Piece Kit! Genuine Commercial Apparatus—Not Toys!

- Wire Up thief-detector, extension phone, electric welder, radio code set, electro-plating, arc furnace, circuit tester, rectifier, 110-volt motor, arc light 4,000-ft. range, secret service phone, generate sun-tan health rays, make electric stove, etc.
- Contains 110-volt A.C. motor, microphone, transformer, polarized test receiver, arc carbons, electro magnet, test compass, plating chemicals, condenser, 110-volt inductance magnet, anodes, test socket, 110-volt power reducer, test cords, clips, etc. Our kits used by leading schools!
- 6 Books Free with kit! Instr., Manuals, Theory Electricity, Radio, Plans for Expr. Lab., Bench, etc.
- SAVE 60% Off! Send only \$3.99 for complete kit and 6 books (value over \$10.) Or, send C.O.D. & stamp bring catalog.

ELECTRICAL SALVAGE CO., Box 524-52 Lincoln, Nebr.

ELECTRIC EYES

Be the first in your community to install electric eye devices and reap a rich reward. Simple electric eyes for opening doors, announcing people in offices, safety protection across doorways and many other uses can be bought at low cost. \$10.00 each with order or C.O.D. brings you a marvelous electric eye complete with selenium photo cell. Operates from 110 volts AC or DC. Money back guarantee. If not satisfied return unit to us in good condition within 10 days and money will be refunded. We can supply photo electric equipment for any purpose, sorting machines, grading machines, traffic counters, laundry counters, oil burner safety controls and many other devices. A postcard will bring complete information for any special applications.

ELECTRONIC PRODUCTS COMPANY, St. Charles, Illinois

BEGINNERS!—BUILD THIS "TINY TIM" 4-TUBE SET

(Continued from page 337)

R2, (b) a change in actual carrier level, or (c) a change of carrier selection.

SEMI-A.V.C. ACTION

At no-signal, bias is determined solely by residual noise level. At low signal level, the bias will be somewhat higher but low enough to permit good 6C5 amplification. At high signal level, bias increases. Thus we have something of an A.V.C. action which works to automatically control the 6C5 amplification to some extent, preventing extremely large orders of power output on the one hand and low V3 gain when signals are weak on the other. Not that we are interested in weak signals in this particular receiver—but it is nonetheless good to know that we have this bias control and that the 6C5 will do a wide-open job on DX when and if it is to be intercepted.

The 6C5 is parallel-plate-fed from "B plus" through a 50,000-ohm resistor R3, and the earphone is connected into the output circuit through condensers C5 and C6, both of which are 0.25-mf. units, tested for low leakage. IT SHOULD BE NOTED HERE THAT THE CRYSTAL EARPHONE MUST BE ISOLATED IN SOME SUCH WAY FROM D.C.; condenser C6 may be eliminated—but both condensers, one in each leg, afford reserve protection and are advised.

A 25Z6 rectifier delivers a pulsating D.C. to the filter system input. The filter, note, requires no audio choke and simply consists of 4 mf. input and output electrolytics and a smoothing resistor R4—which may be anything from 1,000 to 5,000 ohms in value. Due to the low total current drain, resistor filtering is quite permissible. A value for R4 should be selected which will give from 90 to 100 V. "B" output with a minimum of hum. Hum, of course, cannot be tolerated in an earphone or headphone receiver.

THE TUNING SYSTEM

It is quite apparent that a set such as this one will be used primarily to receive programs transmitted by the 4 or 5 network stations in some one metropolitan area. It is further apparent that the conventional ganged tuning condenser takes up appreciable room on any chassis—even if of milgret construction. In this job we therefore dispense with the use of a variable, employ a 2-section selector switch designed for contact shorting as the arms pass across the various points, and wire-in trimmer condensers so tuned that individually or in parallel, as the case may be, they will permit the selection of any one of 5 desired stations.

The capacities are additive in each switch section, one, alone, determining what signal shall be intercepted at the high-frequency end of the band; this one and the next adding to trim to the desired signal lower in the band; these 2 and a 3rd adding to tune in a 3rd signal still lower in frequency, and so on. In other words, as the selector switch arms move across the contact points more and more capacity is added and stations lower and lower in frequency are received. Trimming, of course, must be accurate for maximum gain on each desired signal and precise alignment of the 2 circuits. Fixed condensers cannot be used. (Readers may be interested in noting a preceding article on selective tuning using trimmers in parallel; see "Making the Lazyman '4' Receiver," Radio-Craft, October 1935.—Editor)

CONSTRUCTION

The chassis is formed from a single piece of sheet steel or aluminum 7 3/4 ins. long by 6 ins. wide. A length of 1 1/4 ins. is folded down 90 deg. to form a chassis rear support, and 3 1/2 ins., at the other end, folded up 90 deg. to make the panel for the volume control and selector switch. The complete assembly will be held upright by means of the volume and selector control shafts, which will protrude through the cabinet front wall.

The center part of this folded piece should be stamped with an L1-1 type die for 4 retainer-mounting moulded sockets. Seven small holes will be required for controls, for line-cord entry, and for leads up through the chassis to the controls and to fahnstuck clips to be screwed down at the rear of the wooden cabinet for earphone connection.

Install the 4 octal sockets, positioning each

for shortest possible leads to associated components, grommet all of the 5 holes through which leads will be passed, mount the controls, and solder a 2-point tie-assembly on the front panel (rear surface), as shown on the chassis layout diagram Fig. 31E. The antenna transformer, L1, may be mounted on the panel to the immediate right of the selector switch (toward the right edge of the panel), as it is an extremely small unit. Coil L2 should be installed below-chassis, and so that it will clear socket terminals amply and leave room for bypass and filter condensers.

Connect all filaments, following the circuit diagram as shown in Fig. 1. (One filament of V3 connects to "B minus" and chassis, with V2, V1, and V4 in line for series follow-up to R5, which is the 250-ohm A.C. line-cord filament dropping resistor.) Wire-in all capacities except those to be used for signal selection, all resistors, and all other items. Condensers C5 and C6 should be connected to the terminals of the 2-point tie-assembly mentioned above, and their free leads insulated from each other and properly connected—one to chassis at some convenient point, one to the 6C5 plate.

Resistor R4 is shown in the under-chassis photo as an ordinary carbon resistor, but as some changes in value will be experimentally necessary until proper filtering action is obtained, it might be best policy here to substitute a 5,000-ohm, 10 W. resistor with adjustable tap and a total resistance of 5,000 ohms. Fuses in both legs of the A.C. line are advisable—but there may be no room for installation of these items.

Be sure coils L1 and L2 are correctly connected, with the return for L1 brought not to chassis but to the "high" end of R2. Insert tubes, connect ordinary, magnetic-type headphones to leads wired from C5 and C6, and test for proper voltages and for hum content—adjusting R4 until good "B" voltage is had with a maximum of filtering action.

ALIGNMENT

Add a short temporary antenna, connecting it to the outside lead of C1 or directly to the L1 antenna terminal, decide upon your desired high-frequency limit station, and then solder a variable trimmer to the first selector point in each switch section, making sure both contacts are simultaneously wiped by the two selector arms. See Fig. 1. Return that for the antenna stage to chassis-ground and that for the detector stage to R2, as shown.

Trim each until the desired station is heard and the 2 circuits are in precise alignment. Switch to the number 2 contacts and add trimmers here, adjusting these until their capacity, added to that of the highest-frequency station trimmers (which should not be readjusted), brings in a 2nd desired signal "on the nose."

Wire-in trimmers to points 3, 4, and 5, remembering that each capacity in each section adds to previously-placed capacities as the wiper arms contact them, and adjusting for circuit alignment to stations lower in the band. When this work is completed, you will be able to switch to any one of a maximum of 5 stations (if 5 switch points are available) and without further attention to the trimmers—which, once set, should need but occasional attention and then only after extended periods of set operation.

A small square or oblong cabinet of wood, sized to permit a rather close chassis fit, is suggested. This may be finished as the individual builder desires. That for the laboratory model has its surfaces covered with a cloth material matching certain bedroom furnishings and is provided with a "5 and 10 cent store" draw pull as a "lift" and finishing touch.

An external antenna, as we have earlier hinted, will be neither necessary nor advisable. A few turns of insulated wire, wound around the inside of the cabinet and thumb-tack secured, should afford all the pick-up required for reception of any local station. Volume will be quite adequate—and signal-to-noise ratio good.

RADIO MAKES CINEMA OF PILOT'S HEART

According to a U.P. report of last month the Central Laboratory of Aviation Medicine, Moscow, U.S.S.R., utilizes radio means to listen to and record on film a pilot's heart activity during flight!

SERVICING QUESTIONS & ANSWERS

(Continued from page 353)

Have had the set repaired twice for the same trouble, that is, burned-out 5,000-ohm resistor and 0.05-mf. 400 V. condenser in 1st I.F. stage. These parts are contained in the same can with the 1st I.F. transformer. What would you say was the probable cause for this trouble?

(A) A frequent cause for hum, loss in power and some distortion in Midwest 11-36 receivers has been found to lie with the cathode bypass condensers for the 1st audio and driver stages. These 12-mf. electrolytic units suffer a reduction in capacity due to heat and other causes. It may be advisable to shunt the cathode bias resistors with 25 mf., 25 V. units to determine whether the condensers in question are the seat of the difficulty. Should the hum condition clear, new condensers are easily wired in to replace those at fault.

The fact that the plate filter consisting of resistor and condenser is the 1st I.F. plate circuit has been replaced upon two occasions does not possess any particular significance in itself, since this defect is quite common in this receiver, but the heat generated by the carbonization of the plate filter resistor each time the bypass condenser short-circuited, and the handling of the I.F. transformer and associated wiring, undoubtedly has altered the frequency to which the transformer was originally tuned. A complete realignment of all tuned circuits with a reliable signal generator is advised.

BROAD TUNING, POOR TONE

(35) W. L. Jones, Johnson City, Tenn.

(Q.) I am servicing a model 808 Atwater Kent. This set has the complaint of broad tuning, frequency shifting, with tuning indicator broad and poor tone. What would you say is the cause for this trouble?

(A.) When distortion, broad tuning and incorrect calibration troubles are experienced on the Atwater Kent model 808, with the attendant circumstance of a wide indication of the tuning indicator or shadowgraph, most likely the cause lies with the A.V.C. circuit. First determine the cathode voltage on the R.F. 58 and 1st I.F. 58 tubes (with no signal tuned in), with the 10 V. scale of a 1000 ohms/volt meter. A reading of 1 V. should be obtained from cathode to ground of each of these tubes. Then check the cathode voltage while tuning the receiver to station resonance. The reading obtained now should increase as resonance is reached and fall as the receiver is tuned off resonance. When cathode voltage on the R.F. or 1st I.F. tubes does not increase as stated, check the 0.05-mf. R.F. and 1st I.F. grid filters in the secondary returns of these stages for a "shorted" or leaky condition. A change in value or open-circuiting of the 2 meg. load resistor in the A.V.C. circuit will produce a similar complaint.

FUN WITH RADIO PARTS

(Continued from page 339)

station announcement. Instead, you come in with your own announcement (having previously grounded the antenna or otherwise cut out the radio station in some way), leading off with some such statement as, "This is station W---. We interrupt our program at this point to make a special announcement. Mr. John Q. Pinchpenny has just won a \$10,000 sweepstakes. Will Mr. Pinchpenny please get in touch with this station as soon as possible? We now return you to our studio."

Mr. Pinchpenny, one of your guests for the evening, gets himself into a lather thinking about the \$10,000; and the guests who were previously (and similarly) "initiated" go into hysterics. The trick here is not in the radio-set hook-up, shown in Fig. 4B, but in the "line" you work up for the "broadcast."

How about it, fellows, have you ever put on such a "party" as Mr. Palmer outlines? Radio-Craft will be glad to receive contributions from readers who have actually worked up entertainment novelties, based on radio, not mentioned in this article. Come on! Let's hear from you!

*Silent
Spiral
Connector*



NO SLIDE
NO FRICTION
NO NOISE

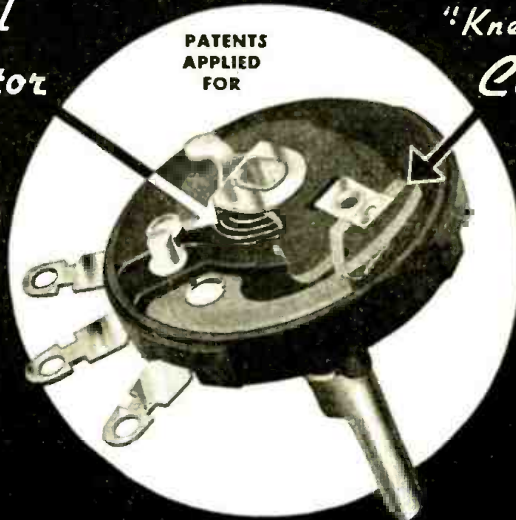

PATENTS
APPLIED
FOR

*5-Finger
"Knee Action"
Contact*



AMAZINGLY
SMOOTH
PERMANENTLY
QUIET

SPECIAL REPLACEMENT *Metallized* CONTROLS

with the New SILENT SPIRAL CONNECTOR
plus 5-FINGER "Knee Action" ELEMENT CONTACT

Out goes noise at the two most critical points in any control!

Sliding, metal-to-metal contact—the most common cause of control noise—is definitely eliminated by the latest IRC engineering triumph, the Silent Spiral Connector. Because it provides positive, continuous electrical connection between the center terminal and volume adjustment arm, there is no chance for noise to originate. With element noise also eliminated by the famous IRC 5-Finger "Knee Action" Silent Element Contact, you have double assurance of the smoothest controls you've ever used—controls that are quiet and stay quiet!

Silent Spiral Connector available only on IRC Special Replacement Controls... designated in Guide with prefix "J."
5-Finger "Knee Action" Element Contact supplied on all IRC Controls.

GET THIS
NEW GUIDE FREE!

The most complete guide ever offered. Contains more than 200 pages listing IRC Standard and Special Replacement Controls for practically every receiver.

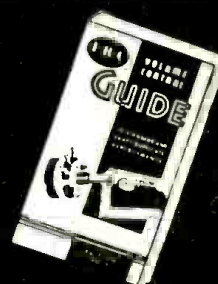

INTERNATIONAL RESISTANCE COMPANY

401 NORTH BROAD STREET, PHILADELPHIA, PA.

Factories or Licensees in Canada, England, France, Germany, Italy, Denmark and Australia

MAKERS OF RESISTANCE UNITS OF MORE TYPES, IN MORE SHAPES, FOR MORE APPLICATIONS THAN ANY OTHER MANUFACTURER IN THE WORLD

AT LAST!



HERE'S THE TUBE COMPLEMENT BOOK YOU'VE BEEN WAITING FOR SO LONG!

SERVICEMEN have been waiting a long time for *any* Tube Complement Book. Now they can get — not just “any” Tube Complement Book — but a big, 168 page manual, so far as we know the most complete and unabridged book of its kind ever printed — and it costs you exactly a quarter.

Just look at what two bits brings you:

1. Tube complement listings for 10,386 models.
2. Listings for 259 companies.
3. Most complete compilation of i-f peaks available.
4. Helpful articles dealing with tube selling, etc.
5. Names and addresses of all active radio receiver manufacturers.
6. And many other features, too numerous to list.

Yes sir! Two bits brings you dividends at the rate of 1000%, in the form of time and money saved. And time and money saved is time and money earned.

Earn yourself some extra time and some extra money. Send 25c and the coupon below for *your* copy of the Sylvania Tube Complement Book. Or see your local jobber: he may be able to supply you.

SYLVANIA

Set-Tested Radio Tubes
Also Makers of famous Hygrade Lamp Bulbs

HYGRADE SYLVANIA CORPORATION
Emporium, Pa. RC-127

Enclosed please find 25c. Send me my copy of your new Tube Complement Book right away.

Name

Address

City State

- Dealer Service Man
 Amateur Experimenter

NEW 15-W. AMPLIFIER FEATURES HIGH GAIN, LOW HUM LEVEL

(Continued from page 351)

Those leads, which must be shielded are so indicated on the circuit diagram, Fig. 1. A long piece of braid running near the back and then along the left side of the chassis is the common ground lead. It terminates, in the rear right-hand corner, onto a ground screw. For general public address work it will not be necessary to actually ground on the chassis. Of course, if the unit is to be installed in a location where there are strong magnetic fields the chassis may have to be grounded in order to maintain its low hum level.

(If the amplifier is to be used as speech input equipment for amateur transmitter purposes the chassis must be very well grounded. This grounding does much to eliminate feedback of R.F. from the antenna system back into the speech line.)

The amplifier is a combination glass-metal tube unit. No attempt has been made to utilize one given type of tube, making the amplifier either all-glass or all-metal. The selection of each particular type of tube was governed by the efficiency of that tube in the working circuit. The 6C6 tubes were chosen for their low hum characteristics. They are non-microphonic—a feature which is non-existent in most metal tubes of an equivalent type. The 6A3s form a low-impedance source, so necessary when the amplifier is to act as a driver unit for a class B stage, and at the same time give exceptionally fine quality of reproduction of the voice input.

WIRING PROCEDURE

No special system of wiring is required. It is suggested, however, that all the solid parts—transformers, chokes, electrolytics, etc.—be mounted before any wiring is attempted. The clearance holes in the chassis, for mounting the various components should be for 6-32 screws. Use a lock-washer under each and every nut—anchoring all parts down solidly and permanently. After these parts are in, the tie-blocks for the small condensers and resistors may be put into place.

The input circuit, with its shielding may be wired-in. The input, by the way, will take care of just about every signal condition with the exception of condenser mikes, which require a polarizing high potential. If a carbon mike is to be used at any time it is to be connected directly to the terminals marked MIC-CT-MIC. No battery is needed, the power for the mike being built into the amplifier.

The very fine quality of this amplifier is due in no small measure to the self-bias, supplied by the type 82 tube. Note that the output from this supply is *negative*, that is, the terminal goes to ground. Be certain that the electrolytic filter condensers are connected properly or they will go “west” in no time.

In wiring use nothing but good resin-core solder. No matter what the label tells you on these “no acid” bottles, don't use them, for your amplifier will, no doubt, go completely sour and sound like a hail storm.

The output transformer will accommodate all series and parallel combinations of speakers. In addition a 250- and a 500-ohm line connection is available.

TESTING THE AMPLIFIER

On completing the wiring of the amplifier carefully check every circuit. A continuity meter will be a considerable help. It will also serve as a ground tester. Take into consideration, of course, that there will be a slight deflection on the meter when checking for grounds due to the bleeder and other resistors. Being assured that all wires are in their proper places, the amplifier is now ready for an electrical check.

The circuit diagram shows, at the various tubes, the voltages to be expected at those points, as measured to ground.

It must be understood, of course, that these figures are the average values to be expected since any variation in the line voltage will give a corresponding variation in the measured voltages. Also, these voltage readings will vary slightly with the commercial variation in the component parts. Differences up to 10 percent are not unusual and will not materially affect the characteristics of your amplifier. Finally,

check your amplifier on a good record or with a good crystal microphone. Give it a good workout for tone quality and for hum. If the unit has been properly wired and the parts laid out as specified the hum will be unnoticeable, even at full power output. The amplifier has been operated under all the conditions of service for which it is intended and has proved to have those characteristics which make a good amplifier “good.”

This amplifier was designed to give the sound engineer fully-matched transformers and chokes with other accessories, to build a better-performing unit, consistent with low cost, than is the case with average custom-built amplifiers whose parts ordinarily come from different sources and which therefore are difficult to match.

LIST OF PARTS

- *One type 4208 plate impedance, T1;
- *One type 2294 input trans., T2;
- *One type 2357 output trans., T3;
- *One type 1751 power transformer, P.T.;
- *One type 2162 filter choke, Ch.1;
- *One type 1122 filter choke, Ch.2;
- *One type 1138 filter choke, Ch.3;
- *One type 1129 microphone-supply filter choke, Ch.4;
- *One type 20303 chassis with all sockets and terminal strips installed;
- *One 20292 cover;
- *One 20420 panel;
- Two National Union type 6C6 tubes;
- Two National Union type 6C5 tubes;
- Two National Union type 6A3 tubes;
- One National Union type 83 tube;
- One National Union type 82 tube;
- Two Muter condensers, 0.1-mf., 400 V.;
- Two Cornell-Dubilier condensers, 25 mf., 25 V.;
- One Cornell-Dubilier condenser, 25 mf., 50 V.;
- Two Cornell-Dubilier condensers, 4 mf., 200 V.;
- One Cornell-Dubilier condenser, 8 mf., 200 V.;
- One Muter condenser, 0.1-mf., 400 V.;
- One Muter condenser, 0.01-mf., 400 V.;
- One Solar condenser, 8 mf., 475 V.;
- One Solar condenser, 16 mf., 475 V.;
- Two Cornell-Dubilier condensers, 25 mf., 100 V.;
- Two M.R.C. condensers, 0.01-mf., 1000 V.;
- One I.R.C. resistor, 10,000 ohm, 1 W.;
- One I.R.C. resistor, 300 ohm, 1 W.;
- Two I.R.C. resistors, 200 ohm, 1 W.;
- One I.R.C. resistor, 0.5-meg., 1 W.;
- Two I.R.C. resistors, 0.1-meg., 1 W.;
- Three I.R.C. resistors, 50,000 ohm, 1 W.;
- Three I.R.C. resistors, 2,500 ohm, 1 W.;
- One I.R.C. resistor, 0.25-meg., 1 W.;
- One Continental Carbon resistor, 0.25-meg.;
- One I.R.C. resistor, 20,000 ohm, 1 W.;
- One Ohmite resistor, 15,000 ohm, 10 W.;
- One I.R.C. resistor, 2,000 ohm, 1 W.;
- One Continental Carbon resistor, 0.5-meg.;
- One I.R.C. resistor, 500 ohm, 1 W.;
- One Ohmite resistor, 3,000 ohm, 10 W.;
- One S.P.S.T. switch;
- Two tube shields;
- Three ft. of ¼-in. wire shielding;
- One 6 ft. line cord and plug;
- Two ¼-in. bar knobs;
- One “Gain” name plate;
- One “Tone” name plate;
- Eight double mounting strips;
- One resistor mounting panel 2¼ x 3 x 1/16-in. bakelite;
- One “On-Off” name plate.

*Names of manufacturers will be supplied upon receipt of a stamped and self-addressed envelope.

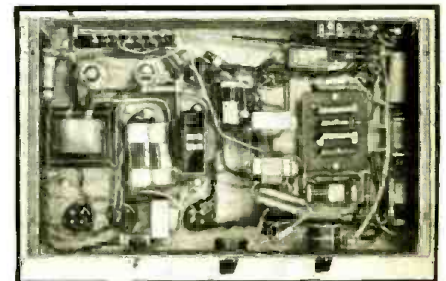

Fig. 8. Underside view of the amplifier.

Please Say That You Saw It in RADIO-CRAFT

NEW CONSOLE UTILIZES "BASS REFLEX"

(Continued from page 335)

For instance, they certainly permit very little low-frequency response. In many console cabinets bass response is maximum—resonance occurs—between approximately 120 and 150 cycles and in table-type cabinets between 140 and 220 cycles which, of course, results in very loud "boomy" reproduction of both speech and many instruments. It is, of course, possible to remove this boom quality by many methods, but ordinarily the means are inadequate unless the bass range is extended; this is true because reproduction of certain types of music will certainly suffer from a deficiency in bass response. The use of electrical compensation in a receiver is only slightly successful when the acoustic system is inefficient, because, excessive compensation limits the apparent output of the system.

It is also well known that the low- and middle-low frequency response depends, to a great extent, upon the "acoustical environment" of the cabinet, that is, (1) the distance of the cabinet from the wall, and (2) the absorption characteristic of the wall. Most of the above difficulties can be charged to what may be termed a "non-controlled rear radiation" from the speaker.

SOLUTION: "CONTROLLED REAR RADIATION"

To remedy this, the *bass reflex* system enclosure is used. This minimizes the short-comings of a cabinet by controlling the rear radiation. By proper design the low-frequency efficiency of the speaker is materially increased. The marked resonant peak which makes speech "boomy" can be eliminated. In the *bass reflex* system a higher degree of efficiency in the output range has been obtained than in any other system heretofore designed to accomplish the same result.

The tremendous improvement provided by this system is very evident from a special test which was made, affording the results shown in Table I.

TABLE I

Comparative Response Characteristics of Open- and Closed-Back Reproducers

Frequency (c.p.s.)	Open Back	Closed Back	Improvement
40	-18	-5	+13 db.
50	-6.5	+1	+7.5 db.
60	+1.2	+4	+2.8 db.
70	+1.0	+6	+5.0 db.
80	-3.5	+7.5	+11.0 db.
90	0	+8.5	+8.5 db.
100	+5.5	+8.5	+3.0 db.
110	+8	+8	0
120	+10	+7	-3.0 db.
130	+10.5	+6.5	-4.0 db.
140	+10	+6	-4.0 db.
150	+9	+5.5	-3.5 db.
175	+7	+5	-2.0 db.
200	+5	+5	0

The effect from 40 to 100 cycles is very advantageous because it definitely brings up the real bass response. Between 120 and 200 cycles the effect is also very advantageous because this removes the "boominess" or so-called cabinet resonance. The *bass reflex* system is effective in extending the range of the loudspeaker approximately an octave. The "port" or rectangular opening, located beneath the loudspeaker opening, which is a feature of the *bass reflex* system behaves as an auxiliary diaphragm.

The large-size reproducer used provides the effective diaphragm area to afford high-fidelity reproduction.

The "Super-Pro" receiver used in this console is identical to the standard model made for table model or rack and panel except for 2 slight modifications to simplify tuning. One of these is the removal of the variable-beat oscillator control; but the C.W.—Modulation switch has still been retained. The other is the removal of the Stand-by switch. Both of these features, while important to the amateur or professional operator, are not necessary for home use. All of the other important features—such as variable band width (3 to 16 kc.), electrical band spread, tropic-proofed chassis, 2 tuned R.F. stages on all bands, tuning meter, and so on—have all been retained.

This article has been prepared from data supplied by courtesy of Hammarlund Mfg. Co.

ALLIED LEADS AGAIN IN VALUE!

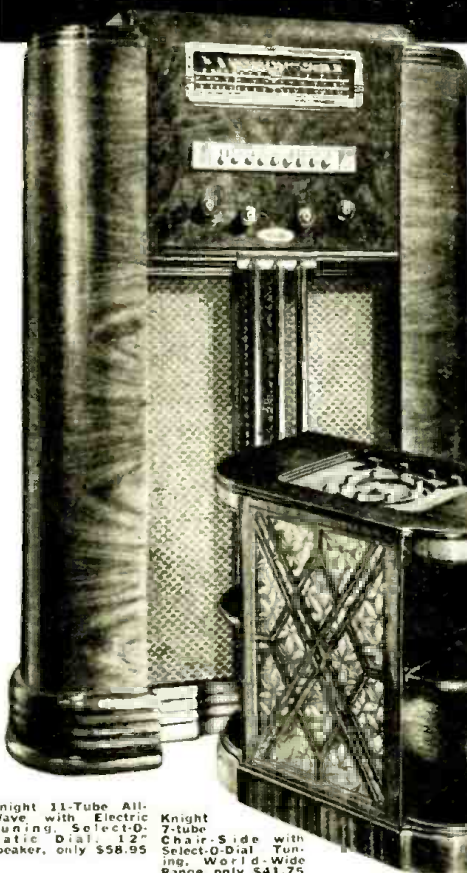

1938 KNIGHT RADIOS OFFER EVERY NEW FEATURE

ELECTRIC PUSH-BUTTON TUNING • FULL VISION DIALS
STUDIO TONE QUALITY • WORLD-WIDE RANGE
AND MANY OTHER "MONTHS-AHEAD" FEATURES
AT PRICES THAT CHALLENGE THE INDUSTRY!

ALLIED has done it again! Now in the 1938 Knights, ALLIED presents radio's newest thrilling features at sensational, typically-ALLIED prices: Select-O-Matic Electric Tuning—a station a second, just press a button! New simplified Horizontal Dials—new Full-voiced Speakers—Broadcast Studio Tone Quality—Advanced RCA and Hazeltine licensed circuits—Newest Tube types—World-Wide Range—the Electric Eye—Automatic Frequency Control—all these features and more, at the season's lowest prices!

Only ALLIED's tremendous volume, low distribution costs, and low-price policy makes these values possible. KNIGHT Radios offer you greater values and bigger profits than any other line. Choose from 61 great models—for every purpose—from 5 to 16 Tubes, for AC, AC-DC, 6 volt, 32 volt, battery and auto operation. See them all in ALLIED's great 1938 Catalog—if you haven't one, just send coupon.

Knight 11-Tube All-Wave with Electric Tuning, Select-O-Matic Dial, 12" speaker, only \$58.95
Knight 7-Tube Chair-Side with Select-O-Dial Tuning, World-Wide Range, only \$41.75

Everything in Radio at Lowest Prices!



KITS

Radio's largest selection, from Beginners' One-Tube to 14-tube Superhet. Write for Free Parts Lists for any kit described in any radio publication.

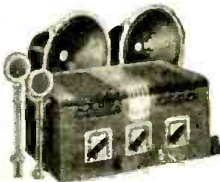

SOUND

Knight Integrated Sound Systems for every PA need—8 to 60 watts—and Inter-Com Systems, 2-way, Selective and Super-Selective.



TESTERS

Every type—analyzers, tube-checkers, set-testers, meters, signal generators—all nationally-known brands, at lowest prices.

Whether you're a Dealer, Service man, Sound-Specialist, or Amateur-Experimenter, you need ALLIED's 1938 Catalog. It brings you everything you need in one book, at lowest prices. Over 12,000 parts, for building or repairing any circuit. Complete Amateur Section—all nationally-known lines of receivers, transceivers, transmitters—factory-built or kit form. Test Equipment for every service requirement, including new instrument-kits, Sound and Inter-Com Systems—Builders' Kits of every type—Books, Tools, Tool-Kits—every radio requirement.

ALLIED's high standards and rigorous testing assure you of highest quality. Fast dependable shipment (stocks all under one roof) saves your time. And ALLIED's prices (possible through tremendous volume) save you money. That's why thousands buy from ALLIED! For free catalog, just send coupon.

FREE

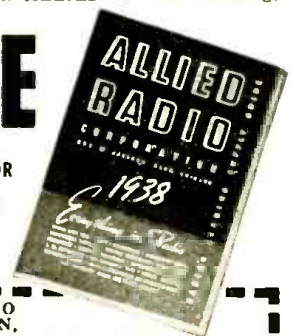

SEND COUPON FOR RADIO'S COMPLETE SUPPLY GUIDE

ALLIED RADIO CORPORATION,
Dept. 2-M8, 833 W. Jackson Blvd., Chicago, Ill.

Send your Free 1938 Catalog

Send Free Parts Lists for

Name

Address

City State

57 other great KNIGHT Models shown in ALLIED'S CATALOG

ALLIED RADIO CORPORATION

833 W. JACKSON BLVD., CHICAGO, ILL.

Please Say That You Saw It in RADIO-CRAFT

—LUIGI GALVANI—200TH ANNIVERSARY

(Continued from page 341)

RADIO-CRAFT
Specifies

A



UTAH
SPEAKER

**TO BRING OUT THE
SUPERLATIVE PERFORMANCE
OF THE CUSTOM BUILT
SUPER-DELUXE
30-TUBE SET**

In any radio, the speaker is the all-important link between the mechanics of the set and its audible performance. In presenting the Radio-Craft 30-tube receiver, "incorporating all the most useful and desirable developments which constitute modern radio," it is significant that UTAH speakers were selected to reproduce, faithfully, the fine performance of this remarkable receiver.



UTAH speakers bring out the best in any radio. And remember, there is a complete line, of every type, correctly engineered and precisely built to UTAH standards. All UTAH speakers have won universal recognition among service men, set builders and the general public, for quality of tone and superlative performance.

Address Dept. RC12 for complete UTAH Speaker Catalog.

UTAH RADIO PRODUCTS CO.
CHICAGO, U. S. A.

TORONTO BUENOS AIRES
ONTARIO, CANADA UCOA RADIO PRODUCTS CO.

"16 YEARS OF LEADERSHIP"

Give Helpful Books for Xmas!

RADIO-ELECTRICITY
Books At Sensationally LOW PRICES

- Latest technical information by nationally known authorities. New popular size books. Crystal-clear explanations. Profusely illustrated. Most outstanding book values in America!
- How To Build Exp. Lab., Work Bench 20c
 - Exper. With 110-V. Electrical Arcs 23c
 - Motor Transformer Experiments 25c
 - Radio Experimental Manual 30c
 - Electrical Experiment Manual 35c
 - Starting An Electric Repair Shop 35c
 - Electrical—Radio Dictionary, condensed electrical education. Newest, most complete at the price. Explains 676 terms. 217 ill. 48c
 - Adjustment & Alignment of Radio-Electronic Apparatus. Equips you to service your own or for others 65c
 - How To Locate Faults in Radio-Electronic Apparatus. Every radio-man and technician needs this book 75c
 - Radio Servicing Instructions, Circuits, data operating instr., etc. Two volumes, 222 ill. Both for .98c
 - Short Course in Mathematics. Two vol., fractions to logarithms, clear, complete. Both for \$1.05
 - Short Course in Electricity and Radio. Two vol., 332 ill. Newest, most complete. Both for \$1.45
- Complete Radio-Electrical Library, all 15 books, fine Xmas gift, postpaid, only \$3.98

ELECTRONIC PUB. CO., Box 323-H, Lincoln, Nebr.

ing electricity by means of a contact established between 2 substances of different nature. This experiment of his, which has become universally known as "Galvani's frog's legs experiment," marks an epoch in electrical (and radio) history.

Little indeed was known 200 years ago about electricity. All that had been transmitted to us through our ancestors was that a piece of well-polished yellow amber was known to possess the property of momentarily attracting certain light substances. Researches were actively pursued during the 17th century but they gave very poor results, until Benjamin Franklin discovered the identity of lightning and electricity and constructed the first "lightning rod." However, it was not until Galvani made his experiments that the difference between (1) static electricity produced by the mere frictional contact of 2 different substances, and (2) dynamic electricity which can be obtained chemically and is found to pervade matter and the earth, was demonstrated. Later on, Volta came and devised the cell, and then almost immediately its derivative, the battery which made available practicable amounts of electricity.

It was sheer chance, we repeat, which brought Galvani to his discovery. One day, as a Professor of Anatomy, he was observing the contractions of a frog's legs which became animated with a sort of spasm each time a flash came out of an electric conductor placed nearby. The contractions were, without doubt, but simple reactions! However, Galvani saw in them but the confirmation of a theory which was dear to him, mainly that they were due to the electricity (later to be called "animal electricity") contained in the animal body. From that time, he devoted himself, heart and soul, to these particular experiments.

He continued to use frogs' legs and one day, he hung some of them on the railing of his balcony. He noticed that violent reactions were produced every time he brought the frog's legs near the iron railings. The contractions were even more noticeable when he would bind the nerves or spine of the little animal to its muscles by means of a metallic wire. Galvani concluded from that, that frogs' legs could be considered as matter charged with electricity, and that the nerves and muscles of which they were constituted could be "unloaded" (discharged) like a condenser by means of the metallic wire. However, he had noticed that the contractions of the frog's legs were even more pronounced when the wire employed was made out of 2 different metals.

Alessandro Volta, Professor of Physics in Pavie (Italy), inspired himself with those experiments and found that the source of electricity was to be identified with the metal and not, like Galvani had believed, with the animal

body. Following this, he made important discoveries, and found among other things that 2 metallic substances of different nature, when put into contact, with one another, produce opposite electricity. Yet by denying the presence of electricity in animal bodies, he made a mistake as was to be demonstrated later on.

It would take us too long to follow, step by step, these wonderful experiments. However before concluding, let us add that in later years, Oerstedt, Arago and Ampere discovered the identity of magnetic and electric currents; they succeeded in obtaining electric currents from magnetic ones, and vice versa. As a science, electricity may be said to exist only from that date. Since then it has not ceased to progress with giant strides and one may verily say that it now governs our whole existence.

Galvani's life went on afterwards in quietness and peace and there remains nothing else worth mentioning except the fact that during the Revolution, having refused to take the oath of fidelity towards the new constitution, which all officials were obliged to do, he was forced for a time to retire from his post which, however, he was not long to take up again. He died in 1798 in Bologna, Italy, which raised a monument to his memory in 1879.

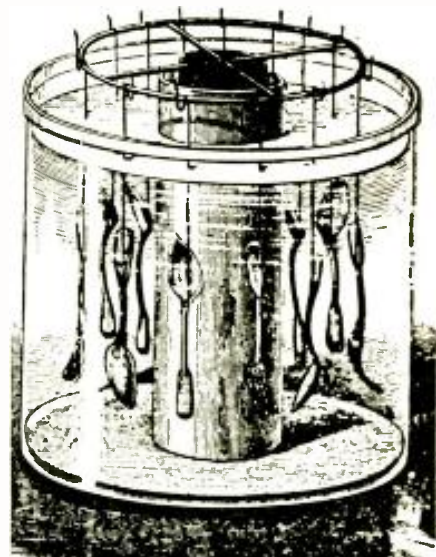

Galvani's electroplating experiment.

**NEW 20-TUBE SET INTRODUCES
DISTORTIONLESS A.F. EXPANSION**

(Continued from page 341)

practically shake the walls of the auditorium. If this program were picked up by a microphone and transmitted without the monitoring, the soft passages would be lost in the transmitter noises, interferences and static, while the extremely loud passages would overload the transmitter so badly and would be so distorted as to be without value.

The control operator, at the transmitter, therefore increases the volume of the soft passages to make them audible and decreases the volume of the loud passages to prevent overload of the transmitter. This operation is called *compression*. The receiver, then, reproduces what is transmitted and not what is played by the orchestra!

It is therefore, desirable in building a more nearly perfect radio receiver to accomplish the opposite of compression or, namely, *expansion*.

This means that the low-volume passages must be made still lower and that the high-volume passages must be expanded to still higher volumes. This has been accomplished in several ways, in the past, all of which are imperfect. One system used a variable-resistance tube in the output stage of the receiver. This method produced some expansion but very seriously impaired the maximum acoustical power output of the receiver. Another method employed an

automatically-variable voltage on an additional grid of one of the audio tubes. This was satisfactory, within a limited range of expansion, but introduced serious distortion when the required range of expansion was used. Other schemes too exhibited this failing.

One company's engineers used all these systems in the past and in using them became thoroughly acquainted with their faults and limitations. It became apparent that any type of an expander affecting voltages on any element of any tube used in the audio amplifier, could not be satisfactory.

This new circuit was then developed, which uses variable voltages only on tubes which are not a part of the A.F. amplifier and therefore can not introduce distortion.

**THEORY OF HAND-OPERATED
VOLUME CONTROL IS IDEAL!**

The circuit in Fig. 1A shows a manually-operated volume control which has been eminently successful for many years. It controls volume between any desired limits from maximum overload to zero (0) without introducing distortion. It, however, must be operated by hand. It became the task of the Midwest Research

Please Say That You Saw It in RADIO-CRAFT

Dept. to adapt this theoretically-perfect type of circuit so that it could be controlled automatically by the signal itself.

Figure 1B shows a conventional resistance-capacity coupled audio amplifier which was used as the basic amplifier of the expander. Figure 1C shows this circuit slightly varied by the introduction of a 0.1-meg. resistor marked R. As long as the resistance value of this unit is low compared to that of grid-leak resistor R2, it has no effect on the amplifier. However, if R2 is made low in value, say 0.1-meg., the 2 resistors R and R2 act as a potentiometer or voltage divider that serves to reduce the voltage to the control-grid of V2 to 1/2 of that delivered by V1. It is now apparent that if R2 be made automatically variable and its value controlled by the signal, we have true, unlimited expansion which can not introduce distortion. This can easily be accomplished by using, in place of R2, the effective resistance of a vacuum tube.

When the grid bias of a vacuum tube is very highly negative, the plate current is at cut-off. Its plate-circuit resistance is then almost infinite. When the tube has zero (0) bias its effective plate resistance is quite low; with the proper choice of tubes this can be made in the order of 10,000 ohms. Therefore, with the plate resistance of the vacuum tube substituted for R2, as shown in Fig. 1D, an expansion range from maximum power to 1/11 of maximum power, is available. This range is much greater than is needed and is reduced to about a 5-to-1 range, by controlling the bias voltage applied to this tube.

In this final circuit, Fig. 1D, you will notice that the audio signal voltage is taken directly from the output of the detector, amplified through a tube V3, and rectified by the diode plates in this same tube. The resultant D.C. grid voltage is then filtered by the resistor-condenser filters to eliminate any fluctuation, and delivered as bias voltage to the control-grid of V4.

HOW FINAL CIRCUIT OPERATES— ON RADIO AND PHONOGRAPH

Let us now consider what happens when a signal is received. This signal is rectified by the diode shown in Fig. 1D and develops an audio-frequency signal voltage across the volume control. This is fed into V1 and is amplified by this tube and by V2 in the conventional manner. This signal is also fed into the control-grid of V3 which tube amplifies it and feeds it into the diode plates of this same tube. These diode plates rectify the audio signal, producing a D.C. voltage across R1 depending upon the amplitude of the audio signal.

This D.C. voltage is filtered by the resistor-condenser filter R2, C1 and C2. The resultant pure D.C. voltage is delivered as a bias voltage to the grid of V4 which is the "control tube". When no signal is being received, no voltage is generated across R1, no bias voltage is applied to tube V4 and the amount of the signal fed to V1 into V2 is roughly 1/11th of the maximum. This gives a very pleasing effect in that it reduces static and interfering noises and, when used with a phonograph, eliminates the needle scratch. When a loud signal is received, say in the neighborhood of 80% to 90% modulation of the carrier, a large signal is fed into the diode plates of V3, a large voltage appears across R1 and a large negative bias is applied to V4. Under these conditions the plate resistance of V4 is very high and the entire voltage delivered by V1 is fed into the grid of V2.

The amount of expansion is controlled by the setting of the variable resistor R1 and is independent of the volume control setting. Note that in actual practice R1 is not a potentiometer. Instead, 2 fixed resistors are chosen to suit the aesthetic taste of the "average" customer.

It is thus seen that when loud passages are being reproduced, the amplifier gain is increased, making them still louder, which compensates for the reduction gain necessary at the transmitter to prevent transmitter overload. When soft passages are received, the amplifier gain is decreased, making them still softer, which compensates for the increase made at the transmitter so that the signal may over-ride extraneous noises. Condenser C3 and resistor R3 are necessary to isolate the "B" voltage on the plate of V4, from the control-grid of V2.

A switch is provided (see photo) to remove the action of the expander when listening to speeches, dialogues, etc., which types of programs do not require expansion.

This article has been prepared from data supplied by courtesy of Midwest Radio Corp.



"I'll show you how to get the jobs that other Radio men Can't handle"

MAKE \$40-\$60 a WEEK

with this

New Kind of Radio Training

It Actually Sets You Up for Business!

Now there's a new kind of Radio training every man should know about if he wants to get on the money end of the Radio Industry. Men taking my training right now are actually earning \$30, \$15, \$20 a week and more in spare time—while they learn. Men who have graduated are holding down jobs paying \$60 a week and up.

Make More Money Quick

My course is arranged so that you get practical lessons right at the start. Quickly, you are ready to begin servicing sets. Useful, simple job sheets show you every step to take. And you have the equipment to handle these jobs properly. Time and time again my students write in to tell me they are handling jobs other Radio men couldn't handle. That's because my easy to understand lessons and professional equipment make you a Real Radio expert.

No Experience Needed

Old-timers and new comers are taking this new kind of training and making real money in Radio. If you are a Radio man now, you know now is the time to get extra training and bigger pay. If you are just about to enter Radio, now is the time to start taking this thorough, easily-learned course. Everything is clear. Everything practical. You learn business methods, gain self-confidence, get the satisfaction that nothing but quick cash in the pocket can give you.

Get the Facts

Mail the coupon at once for a FREE copy of "More Money in Radio" and also a FREE "BUSINESS BUILDER."

BIG OUTFIT SENT

As a regular part of my training I send you a Big Outfit, including Triplet Tester, complete set of Rider Manuals, Professional Tool Kit, Repair Parts, Work Sheets and Fly Electric Etc.

GET FREE BUSINESS BUILDER SERVICE MEN! NOTE

For you men already in the business I have my famous "Master Service Course" consisting of 17 important and practical lessons. Describes the actual how to do it. Practical, modern and easy to understand. Every service man needs this special course. Nothing like it in print. Represents years and years of experience at actual Radio Service work. The free book "More Money in Radio" tells about how courses. **TERMS AS LOW AS \$3 PER MONTH. IRON-CLAD MONEY BACK AGREEMENT** fully protects you.



GET FREE BOOK

Mail Coupon Now

Sprayberry Academy of Radio, F. L. Sprayberry, President, 20-P University Place, N.W., Washington, D. C.

Please send me a free copy of "More Money in Radio" and also a free "BUSINESS BUILDER."

Name Age

Address

City State

Paste coupon on penny postcard, mail TODAY. If interested in Service Course only, check here ()



FREE
This New
44 Page
1938
RADIO
CATALOG



• NEVER OFFERED BEFORE •

An opportunity to earn up to \$100 weekly in commissions, by becoming a MODELL representative in your community, without any investment. This opportunity is open to live wire **SERVICEMEN—RADIO SALESMEN—AGENTS**, everywhere. No experience is necessary. Thousands of men located in cities, towns, hamlets throughout the world, have found the MODELL plan so simple and effective, their letters of praise and thanks are pouring in daily. We give you every kind of assistance in developing and building up a permanent business of your own. Territory is now being allotted to full or spare time men. Rush coupon below for details and our big 44-page catalog.

Modell's Since 1889
AGENCY DIVISION, DEPT. D-7
CHICAGO, ILL. 56 W. Washington St. ATLANTA, GA. 87 Fourth St. NEW YORK, N. Y. 55 Cortlandt St.

MODELL'S—Agency Division, Dept. D-7
Gentlemen:
CERTAINLY I'm interested in representing your Company in my community. Send me FREE your 44-page New 1938 Radio Catalog and full particulars how to make money.

NAME

ADDRESS

CITY STATE

RADICALLY NEW! "MACHINE-GUN" MIKE "SHOOTS" AMERICAN LEGION PARADE

(Continued from page 332)

recently announced a new directional mike, which has been temporarily and popularly labeled the *machine-gun microphone*.

phone is more directional to high frequencies than to "lows."

Figure 2C shows the response for different angles of pick-up in the new microphone.

CONSTRUCTION DETAILS

As the photos show, it consists of a number of tubes of uniformly different lengths. This tube assembly is called the *acoustical impedance element*. At the end of this element is a standard dynamic-type microphone.

HIGH-FIDELITY PICK-UP ONLY WHEN "GUN" HITS "BULL'S-EYE"

An extremely interesting and enlightening observation is that *frequencies below 200 cycles are not greatly affected by the angle* (at which they arrive) because the low-frequency response of any diaphragm-type microphone is independent of the angle at which the sound arrives for all angles less than 90° from the forward axis of the microphone. (This is clearly shown in curve 3 of Fig. 2C.)

Actually there are about 50 tubes all made of an aluminum alloy and ranging in length from 1½ ins. to 5 ft.; the difference in length of one tube to the next is uniform. The overall diameter of this tubular structure is 3 inches. All of the tubes, open at both ends, terminate at one end flush with the diaphragm of the microphone, except for a slight cavity or air chamber, as shown in Fig. 1, and at the other end are cut off straight-across. The total weight of the unit is only 7 lbs.

As these curves show, the microphone has a flat response curve within 5 db. from 35 to 13,000 cycles (approx.) to sounds arriving within an arc 10° off either side of the forward axis of the microphone.

Each tube resonates at a different frequency depending on the tube length. Due to the large number of tubes and the fact that their resonance points are so close together this "acoustical impedance element" can be considered, for all practical purposes, as non-resonant. Its *acoustic resistance is claimed to be equal to that of free air*. The question then arises, "If the tubes act like ordinary air, wherein lies their merit in obtaining directivity?" Let us now look a little further.

This means that within a 20° arc the response is quite flat. At 15° off the axis (that is, to either side) the response is flat from 35 to 6,000 cycles; above 6,000 cycles there is a loss of about 20 db. At 30° off, the response is flat from 35 to 1,500 cycles; above this there is a 20 db. loss. At 60° off-axis all response above 350 cycles is attenuated 20 db.; and at 90° everything above 200 cycles is attenuated 20 db.

"SECRET" OF DIRECTIONAL PROPERTIES

The reason for the directional properties of the microphone can best be explained by reference to the accompanying sketches. Figure 2A shows sound rays (indicated by arrows) arriving from a point in line with the axis of the unit. Consider the line XX as the wave-front for the sound waves and the line X1X1 as the diaphragm. The distance from X to X1 is the same for all the sound rays. Some will reach X1 by traveling through a long tube and others will reach X1 by traveling through the open air and a shorter tube. But in all cases the distance traveled is the same and the rays will strike the diaphragm simultaneously.

Since the important voice frequencies (from an intelligibility standpoint) are from (about) 300 to 3,000 cycles the microphone will almost completely exclude all voices which are more than 60° off the forward axis. Engineers at station WOR (Newark, N. J.) state that it is possible for 2 people on either side of the microphone to talk to each other across it without their voices being picked up!

ADVANTAGES OF THE "MACHINE-GUN" MIKE

Most background noises on outdoor and auditorium pick-ups consist of the higher frequencies. Since this unit discriminates against high frequencies arriving from anywhere outside a 30° arc either side of center such background noises are sharply attenuated while the desired source of sound is picked up with no frequency discrimination.

A further interesting advantage of the unit is for pick-up in an auditorium with excessive reverberation. An ordinary microphone placed only 2 or 3 ft. from the sound source will pick up the sound directly plus the reflected sound from the auditorium walls and ceiling. If the acoustics are bad the microphone pick-up will suffer from loss of intelligibility. If the machine-gun mike is used it will pick up *only* the sound source and *exclude* the reflected high frequencies which are generally the cause of excessive reverberation. So no matter how bad the reverberation is the microphone pick-up will be perfectly clear!

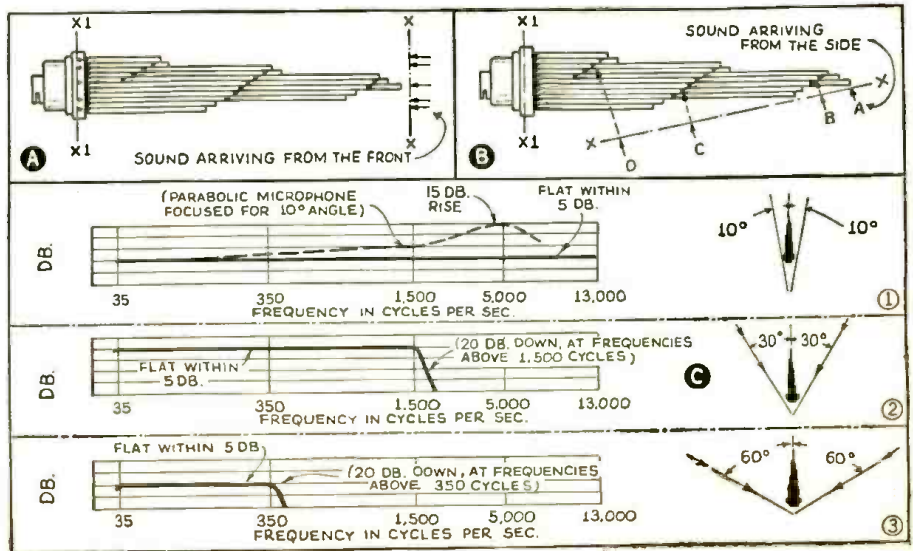

Fig. 2. At A and B, principles of directional properties; C, response vs. angle of incidence.

Please Say That You Saw It in RADIO-CRAFT

OVER 1500 CASE HISTORIES TO SPEED UP YOUR SERVICE WORK

Get the world's greatest collection of "Case Histories"—in Ghirardi's time-saving 1938-1939 RADIO FIELD SERVICE DATA BOOK. Each one tells you exactly which part in the set is causing the trouble—and how to remedy it! No fussing, no cussing—you get directly to the seat of the trouble in a few moments! Think of the work you'll save by having these servicing short-cuts at your elbow. Once you get into the habit of first referring to Ghirardi's "Case Histories" before starting every service job, you may save over 50% of the time you are now spending in trouble-shooting. That's the first one feature of this great Data Book. You'll also get the 1-1/2's of over 6,000 superhets, 66 Car-wiring Diagrams, Auto-Radio Installation and Ignition system interference data for all cars, and over 25 other indispensable tables and charts for shop and job reference. This book is kept always up-to-the-minute by a regular Supplement Sheet Service.

Get the servicing text, too!

Get the DATA Book together with Ghirardi's famous MODERN RADIO SERVICING, a clear, complete and comprehensive explanation of everything about modern servicing instruments and practice. It gives you a whole big 420-page section on Test Instruments (theory, operation, construction, with diagrams, etc.); Trouble-Shooting and Repair methods, Noise-Elimination, Auto-Radio Installation and Servicing, AVC and QAVC Circuits, Aligning Superhets, etc. All "417 Essentials" of successful radio service work are explained in fully-illustrated—in this amazing collection of practical quick-use servicing information. These 2 books give you "the whole works"—shop reference data and knowledge you really have to have. Get them today! Sent Postpaid Anywhere!

MODERN RADIO "SERVICING"
RADIO FIELD SERVICE DATA BOOK
1800 PAGES* 813 ILLUS. \$6
Both Books for \$6



NAME
ADDRESS

NEW!
MODEL T9
CRYSTAL MICROPHONE
\$19.50 List



With Stand As Shown \$22.50
NEW SHOCK PROOF INTERIOR
Ask For Bulletin T9
THE TURNER COMPANY
Cedar Rapids, Iowa
Licensed Under Patents of The Brush Development Co.

Model 557
 Complete
 Dealer Price Only
\$18⁹⁰

★ ACCURACY ★

Guaranteed In This Low Price Signal Generator



★ Wherever you go you will hear praise for Model 557 Direct Reading Signal Generator. Continuous use day in and day out has clearly demonstrated its remarkable accuracy and reliability.

Model 557 Direct Reading Signal Generator uses plug-in type coils. Five frequency bands are covered from 110 to 20,000 K.C., all fundamentals. Completely shielded for static and magnetic fields. Attenuation and stability are outstanding features. Strong signals both modulated and unmodulated are furnished.

Each individual coil is separately calibrated by an exclusive method of peaking with trimmer condensers. Furnished complete with batteries and accessories.

1% Accuracy to 3,000 K. C. • 2% for Higher Frequencies • Range 110 to 20,000 K. C.



READRITE METER WORKS
 1216 College Drive, Bluffton, Ohio

—Please send me information on Model 557 Signal Generator. —I am also interested in—

Name

Address

City State

HOW TO MAKE THE RADIO-CRAFT SUPER-DELUXE 30-TUBE SET

(Continued from page 334)

(11) Mount the resistors and condensers straight fore and aft as shown in the photographs. Placing these small parts at all odd angles makes for a messy job.

(12) Try to wire up each circuit complete before going to the next one. This may not be easy because of the tie-up between circuits.

(13) Check each component before installing, no matter if it is brand new, it might be defective.

(14) Check each circuit as you go along. This will save you the tedious job of an overall check when the wiring is completed.

(15) The shielding requirements are simple; shield plate and grid leads of I.F.T. 1 and 2, and all audio leads which are longer than 6 ins. Instructions for alignment cannot be given as yet because 10 of the tubes are heated from the power transformer on Chassis No. 4. However, if a filament transformer is available, it will be possible to try out the set by plugging Chassis No. 1 to No. 2, and tracing the audio output connections on Chassis No. 2.

Next month Chassis No. 3, the 60-W. Audio Channel, will be described.

We take this opportunity to apologize for failing to advise Radio-Craft

readers that, due to lack of space, it was necessary to hold over Part III (section B of which we have just concluded, above) of this serial.

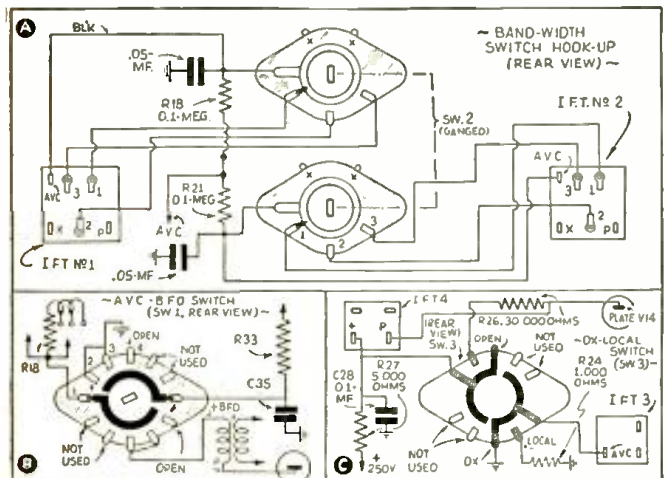

Fig. 12

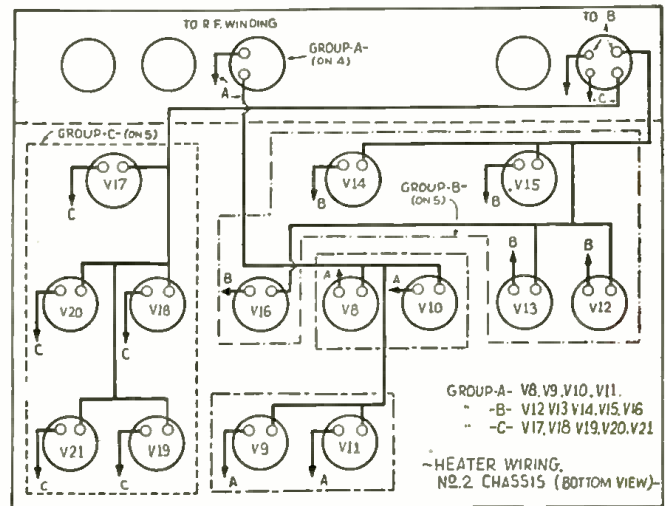

Fig. 10

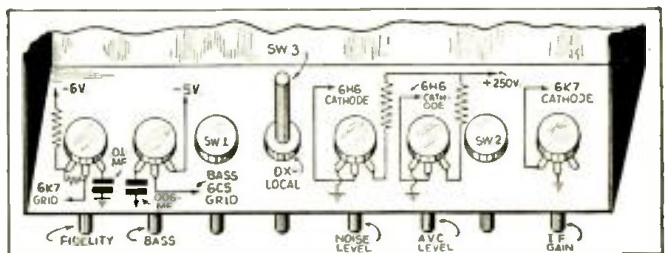

Fig. 11

Please Say That You Saw It in RADIO-CRAFT

"CENTRALAB - WILL STAY QUIET!"



says Mr. V. E. Chandler of Louisville.

Sh! for 12 years off and on he has used these quiet controls . . . without once waking up old lady trouble.

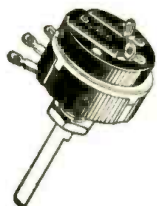

Mr. Chandler, well known radioman of Louisville, Ky., writes us in a loud voice how very well pleased he is with QUOTE: the only control that I have ever found that will stay quiet. UNQUOTE.
Need we go on quoting?

Centralab

MILWAUKEE WISCONSIN

BRITISH CENTRALAB, LTD.
Canterbury Rd., Kilbourn
London N.W. 6, England

FRENCH CENTRALAB CO.
118 Avenue Ledru-Rollin Paris XI, France

Save Money on everything you buy . . .



The New BARGAIN BULLETIN

Your Guide to Hundreds of Outstanding Values.

FREE Write today for this outstanding new BARGAIN BULLETIN—there is no obligation on your part. High quality merchandise at sensationally low prices! Radio Sets, Parts, Sporting Goods, Watches, Clocks, Typewriters, Cameras, Novelties and many other items at real savings to you. Fair Dealing—Prompt and Courteous Service, always. Send for your Free BARGAIN BULLETIN now, try us, and be convinced of our superior values and service.

RADIO CIRCULAR CO., INC.
DEPARTMENT RC
915 Broadway New York, N. Y.

"ELECTRIC-EYE" PROTECTS WILD GAME

(Continued from page 333)

IMPROVED "ROBOT" GUARD

A recent improvement has made the entire action automatic, thereby making it impossible for the system to function except for animals.

Instead of operating the push-button affair the weight of the car (or motorcycle) is utilized to operate contact planks (see Fig. 1) which are installed across the highway at both ends of the arch. The distance between the contact planks is about 6 to 10 ft. Due to the fact that rather strong springs support these planks, animals even of considerable weight are unable to depress them sufficiently to make electrical contact. The weight of a car however will do this quite readily.

Merely depressing these plank contacts is not sufficient to silence the searing device for the successive planks must be depressed at regular intervals. Expressed more simply this means that the car must not stop but must keep going so that the front and rear wheels will depress the plank contacts at the stated intervals. Thus the system is fool-proof since it is able to distinguish between man and automobile, and beast.

POWER SUPPLY

Another design detail of interest is the manner in which the power supply problem was solved. The preserve grounds, being quite a distance from any power line, the "searing" apparatus had to be operated entirely from batteries as shown in the schematic, Fig. 2. Current supply for the exciter lamps and the heater current for the amplifier tube is provided by a large 6 V. lead-type storage battery which lasts for many months. The plate supply for the P.E. cell and the amplifier tube is obtained from dry-cells. The horn and headlights are operated by another lead storage battery. Actual operation of this "scare" system has shown that the power supply is adequate for operation over long periods of time. All devices are installed inside the arches and are shielded against "pranksters" by a heavy wire fence. The current drawn by the entire system as indicated on a milliammeter is adjusted occasionally by forest rangers.

(This article has been prepared from material furnished specially to Radio-Craft by AEG [Germany], via International G. E. Co.)

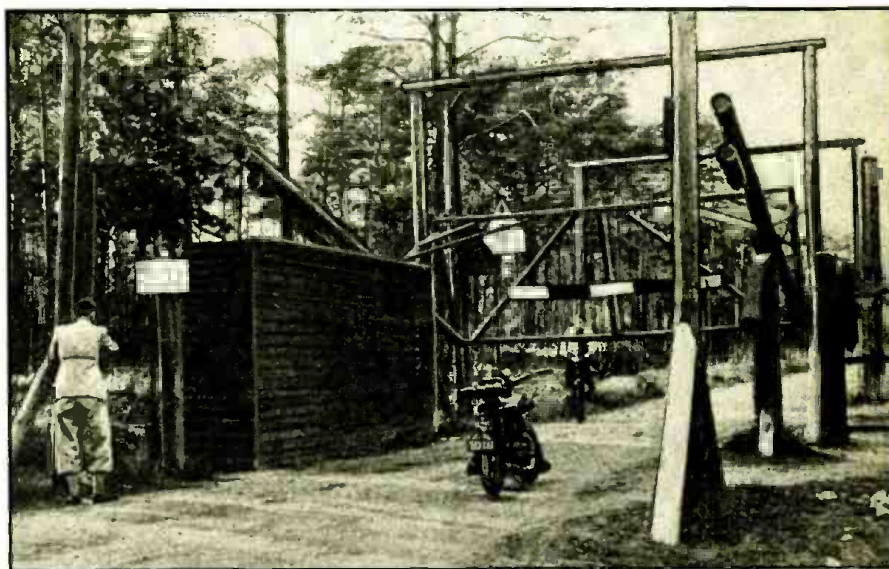

This huge wooden turnstile formerly was placed across all roads leading in and out of the German game preserve to prevent the animals from straying from their grounds. Motorists had to stop their vehicles, hoist the barrier, pass through, lower it once more and then continue on their way. Most motorists neglected to lower the barrier, thereby negating the advantages of its existence. The new electric-eye system works entirely automatically and is fool-proof since it is able to distinguish between man, and automobile, and beast—functioning only for the latter.

TELEVISION STUDENTS LEARN BY MAKING CATHODE-RAY TUBES

(Continued from page 335)

able and flexible, it will straighten out and adjust itself as it cools down, provided it is allowed to cool slowly. The glass contracts slowly as the temperature falls so it must be allowed to stretch evenly until it solidifies to where it will not stretch any longer. If it continues to cool and the extreme portions of the bulb are very rigid, then the glass will crack because of the tremendous force exerted by the shrinking, therefore, it is of the utmost importance to soften the entire vicinity of the bulb where the glass is being "worked," and then VERY SLOWLY reduce the heat from this "flexible" temperature to that of completely-cold glass.

This process is called *annealing*. The thicker the glass is, the more slowly it must be raised and lowered in temperature. Considerable experience is required to properly handle the heating and "working" of glass vessels.

FINAL INSPECTION OF SCREEN

When the bulb is removed from the spinning machine, the end is examined. We found that this should show a glazed-porcelain appearance where the crust comes in contact with the glass.

If it has the usual white appearance of the screen material, it shows that the material has

not fused itself to the glass. If any spots are white, it means that those spots have not adhered to the glass, and the bulb must be again raised in temperature and the flame blown against the soft glass once more. After a little practice, we were able to get the screen properly adhered every time.

The bulb is next placed over a high-pressure washer where the excess screen material is washed off leaving just a screen 1 crystal thick and very even! Such a screen has the highest luminous efficiency.

Part III will continue this interesting discussion.

HEINRICH HERTZ PROVES EXISTENCE OF RADIO WAVES! —50 YEARS AGO

(Continued from page 328)

over in celebrating, this year, the 50th anniversary of his successful experiment, acclaim his achievement in those early experiments and honor his memory.

THE RADIO MONTH IN REVIEW

(Continued from page 327)

Sydney, Australia, will entertain a World Radio Convention April 4 to 14 next year, it was announced last month in a S.W. broadcast from the Antipodes, over VK3ME, Melbourne.

"A West End wedding at East End prices." Rev. Frank Moore of Welling (London suburb) advertises. The secret—a P.A. system reproducing the bells of fashionable St. Margaret's, near Westminster Abbey, and phonograph records of fine organ music.

Radio-controlled planes will be used for anti-aircraft targets under a new system, the British Air Ministry announced last month. They are launched, pilotless, by a catapult; and operated from a master-control switchboard on the ground.

HOW TO CONDUCT A SOUND-ON-FILM RECORDING STUDIO

(Continued from page 344)

second, so that at 9,000 cycles, for instance, there are 9,000 variations for every 18 ins. of film. The tone quality at these high frequencies is thus dependent on the resolving power of the emulsion.

A special sound film may partly eliminate this problem. The RCA solution, however, is the use of ultra-violet light in recording. An incandescent bulb of high ultra-violet output is used, but for lenses quartz must be used, since glass lenses will not transmit this light. It has been found that with ultra-violet light, the film has an unusually high resolving power, and so the difficulty of recording high-frequencies is largely overcome. (There is no limit to how low a frequency may be recorded and reproduced on film.)

MIRROPHONIC SYSTEM

A very recent development by Western Electric is the Mirrophonic System of recording and reproducing. Numerous changes are included in this system. In the recording end, a special valve has been designed. Instead of one pair of valve ribbons, 2 sets of ribbons are used at right-angles to each other, one horizontal and the other vertical, but both in the same plane.

The assembly is push-pull operated, that is, one set of ribbons operates on one half-wave and the other set vibrates in response to the other half. In this way it is possible to record faithfully a greater range of frequencies with less waveform distortion. This balanced system is also combined with the noiseless feature so that a greater range of volume is also secured. The Mirrophonic reproducing system is composed of a new improved amplifier of much smaller noise output, improved photo-cell circuits, and loudspeakers of cellular construction.

A Mirrophonic recorded film has the usual streaks of variable density across the film and also very fine streaks running the length of the track. Vibration of the horizontal ribbons results in the horizontal streaks, while the movements of the vertical ribbons result in the vertical streaks. See Fig. 2F.

DOUBLE SYSTEM

It is possible, of course—and in fact it is the method today—to use one negative film on which to record both track and picture. First the film passes through the sound aperture and then the picture aperture of the same camera. In this way, one film will carry both sound and picture and will be processed as one unit.

The double system, however, uses 2 films during a recording. A negative film in the camera takes the pictures and another film in the recorder takes the track. In this way the best type of film for each will be used: probably a super-panchromatic negative film for the scenes and a special sound film for the track. This method allows the processing to take place separately so that each film has whichever type of development is best suited to it. A disadvantage is the added cost.

Part II will discuss the actual requirements and operation of a sound-on-film recording studio.



INCREASE YOUR PROFITS

With the Latest Test Equipment

You know how important it is for a serviceman to keep up to date. That's why Wards big new 1938 Radio Catalog—just off the press—lists the finest up-to-the-minute testing equipment... the most recent books, crammed with authoritative servicing information... service supplies incorporating important new developments in the field—everything you need to do your work more efficiently and MORE PROFITABLY. Mail coupon TODAY!

Earn as You Pay... Equipping yourself properly doesn't require a large investment. Ward prices are always low and WARDS MONTHLY PAYMENT PLAN makes it possible to have ALL the equipment you need when you need it! Terms as low as \$2 Down and \$2 a Month.

Fill out the coupon below and mail it for your copy of Wards new 1938 Radio Catalog—Equip yourself for increased profits in 1938!

MONTGOMERY WARD • CHICAGO

Mail Coupon Today

For FREE Copy of WARDS 1938 RADIO CATALOG

Assure Yourself of a Copy. Mail this Coupon TODAY!

MONTGOMERY WARD, DEPT. RZ-4,

Please send me my copy of Wards big, new 64-page 1938 Radio Catalog at once.

Name

Street or Box

City State

BEFORE

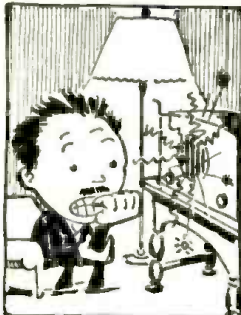

AND

THE SERVICEMAN'S VISIT WITH KENYON REPLACEMENTS

In radio, audio and power components are the important links, quality and performance depends upon them. Be sure to specify Kenyon, the name that has stood for advanced engineering, quality and dependability for years.

AFTER

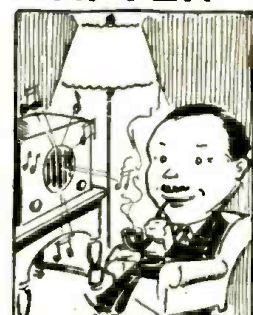

Our Replacement Catalog Contains over 100 Audio and Power Components. Obtainable upon request

KENYON TRANSFORMER CO., Inc., 840 BARRY STREET NEW YORK, N. Y.

SHORT-WAVE RADIO LANDS ARMY PLANE WITHOUT HUMAN AID!

(Continued from page 331)

as just noted. The *directional relay*, which interlocks the *radio compass* and the *gyro pilot* and which therefore causes the change in heading of the airplane, is shown at B in Fig. B. Adjacent to this relay is shown the *radio compass* marked C, the frequency of which is automatically set by the interaction of the *marker beacon receptor* D working in conjunction with the *frequency selector* E (insert 1, Fig. B). The pilot of the airplane is informed as to the correctness of automatic settings by observing the *frequency selector indicator* F (insert 2, Fig. B). (That is, when the airplane passes over the marker beacon, the frequency changer in the airplane is set automatically in order to select on the radio compass receiver the frequency of the next succeeding station. In other words, the impulse received in the airplane from passing over the marker beacon is used to start in operation the frequency selector and changer.)

Through the automatic and cooperative action of these devices, the airplane heads to the *compass guiding station* (Fig. C) farthest from the landing field as shown in Fig. A. Upon reaching that station the frequency is automatically changed to Station No. 3 where it is again automatically changed to the frequency of Station No. 2 where the frequency is again automatically changed to that of Station No. 1 while at the same time the engine throttle is automatically operated by the *throttle engine* shown at G (insert 1, Fig. D); and again shown in H, Fig. D. (That is, the ground radio equipment operates the same as lights burning on the ground. They are placed in operation by ground operators and nothing is done to them until their use is no longer required and they are turned off. The effective range of the markers, at low altitude, is throughout a circle $\frac{1}{2}$ -mile in diameter.)

The throttle engine is interconnected with the altitude control in such a manner that should the airplane reach its minimum altitude prior to reaching radio station No. 1 the throttle engine will be so actuated to control the airplane in such a manner that it will maintain accurately the minimum altitude required for the operation of the automatic landing system.

After passing Station No. 1 the throttle engine

is so actuated that the airplane maintains a *selected glide angle* and *rate of descent* until "ground contact" is made. When ground contact is made, the throttle engine is further actuated by the *landing-gear switches*, one of which is shown at I in Fig. E2, which in turn causes the engine to be idled and proper braking applied.

CONCLUDING COMMENT

There are 4 mobile (truck) ground transmitting stations as shown in Fig. A. Each truck, shown in Fig. C, carries 2 transmitters; one (which has a transmitting range of about 35 miles) is for guiding the airplane by means of the radio compass to the truck position. These transmitters operate in the radio beacon band of 200 to 400 kilocycles. The other, or marker beacon transmitter, operates on the ultra-short wavelength of approximately 4 meters.

At the present writing, the automatic landing system has been flown so that all of the landings made to date have been made under cross-wind conditions varying in intensity as high as 11 miles per hour.

The *Sperry gyro pilot* has been used throughout as the automatic flight control feature of the airplane. Certain additions to the Sperry pilot have been required in order to provide for the automatic control of direction. At J, Fig. F, is shown the Sperry gyro pilot installation; left of this unit is shown the *master landing switch* (1) and the *auxiliary reset switches* (2, 3, 4 and 5).

The series of tests conducted through the last 2 years have brought many humorous incidents not the least of which have been such terms as "nervous shoe laces" and "jittery hands" which have always been evident to the observer watching the pilot keep "hands off" during the automatic landings.

Figures G and E1 are views of the airplane used in the conduct of all of the experiments on the Air Corps automatic landing system. In these photographs, the various antennas are identified as: 11, the antenna for the communications transmitter and receiver; 12, the balanced antenna for the radio compass; 13, the radio compass loop antenna; and 14, the marker beacon receptor and its antenna.

CINAUDAGRAPH

Speaker



CINAUDAGRAPH

Magic Magnet Speakers

—extensively utilized by all leading radio receiver and P. A. equipment manufacturers—are available in a complete range of sizes from 5½ to 18 inches, to meet your every radio requirement.

If you demand utmost dependability and fidelity of reproduction from your equipment—insist on Cinaudagraph P. M. speakers. Carried in stock by all progressive distributors. Free descriptive literature on request.



CINAUDAGRAPH CORPORATION

Speaker Division • Stamford, Conn.



Quiet Your Razor to Quiet Your Radio!

Filternoys Suppressor F01DH is an approved plug-in device to be attached to any electric razor and plugged into the electric fixture. It takes the noise of an electric razor's motor out of your radio programs.

CONTINENTAL Filternoys F01DH, list price \$1.00, offers radio servicemen a handy profitable item to sell on many service calls. Carry a few in your kit. Any **CONTINENTAL CARBON** distributor can supply you.

CONTINENTAL CARBON Inc.

13914 LORAIN AVE., Cleveland, Ohio
Also, Toronto, Canada
Makers of Carbon Resistors, Paper Condensers, and Noise Suppression Filters
Enclosed find 10¢ in coin or stamps for my copy of Handy Pocket Data on Radio Interference Elimination.

Name Address

City State

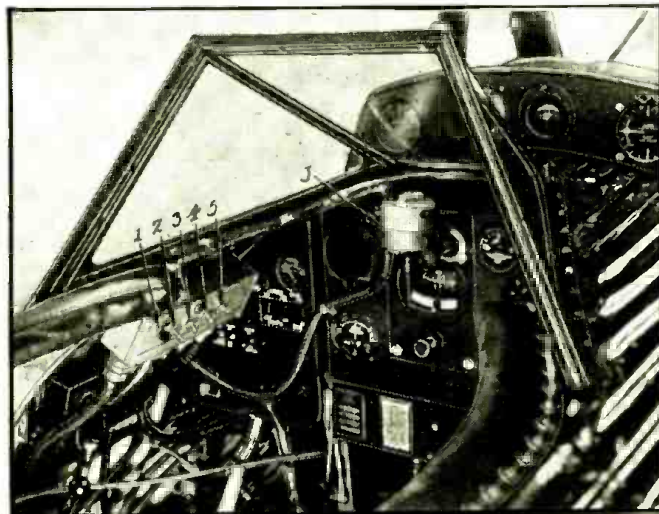

Fig. F. The gyro pilot or "automatic pilot" shown at J permits automatic flight control for an almost indefinite period. The master landing switch (1) and the auxiliary reset switches (2, 3, 4 and 5) are additional items for use in automatic landing.

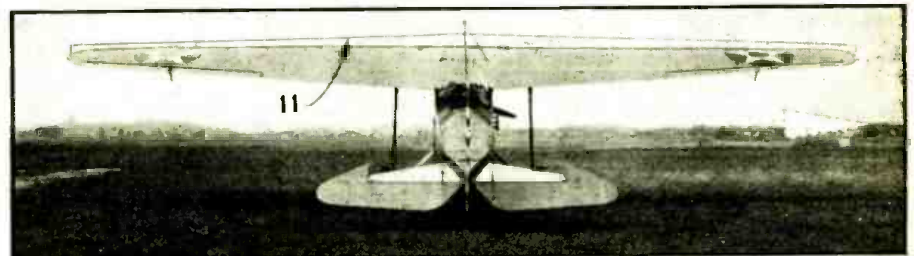

Fig. G. At 11, the communications transmitter and receiver antenna; Fig. E, pg. 331, shows others.

Please Say That You Saw It in RADIO-CRAFT

SHORT-CUTS IN RADIO

(Continued from page 350)

defect, the reproducer can be made as good as new by coating the spider with orange shellac. (See Fig. 5.) This makes it stiffer.

I cured a bad rattle in an auto-radio speaker using this scheme and it has given excellent service since.

Naturally when the rattle is due to voice coil distortion or off-centering the scheme here shown will do no good.

E. W. HILL

HONORABLE MENTION

HOME-MADE RACKS FOR PANEL EQUIPMENT. In building some radio equipment I had need for a relay rack. As commercial racks were so expensive I decided to build my own.

Two old bed rails were obtained from the junk yard and cut to the desired lengths. They can either be bolted or welded together in the form of a rack. The finished product makes a very sturdy and efficient rack.

The general idea is illustrated in Fig. 6.

ROBERT DUNCAN

HONORABLE MENTION

BOOSTING CAPACITY OF VARIABLE CONDENSERS. Missing my calculation on capacity just a little the sketch, Fig. 7, shows how I increased the maximum capacity (partly at the expense of the minimum capacity which thus was raised) of a 350 mmf. (or "0.00035-mf.") variable condenser.

The mica plate being mounted onto the rotor plate of course slides between the stator plates when the rotor assembly is turned. In the particular instance mentioned only a single sheet of mica is required; of course the same idea may be applied to the remaining rotor plates as necessary. You aren't getting something for nothing by using this scheme—the trick is that the mica has a higher dielectric capacity than air and a power factor not nearly as good for R.F. work—however, where maximum circuit selectivity is not required, and for general experimental work this short cut solved a problem.

WALLACE LEIBER

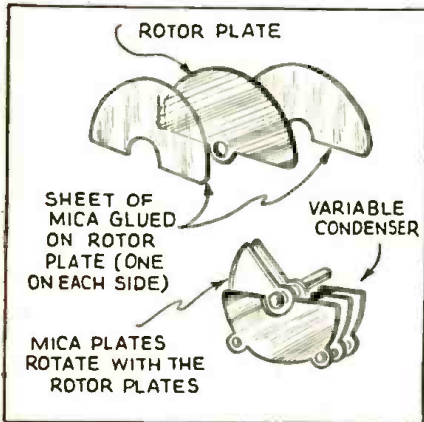
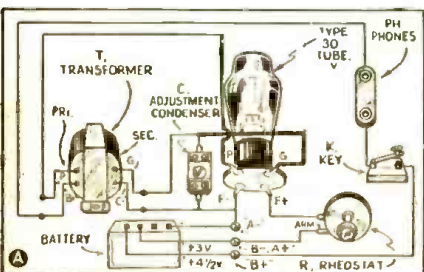

Fig. 7. Altering "dielectric capacity" boosts maximum of variable condensers.

A CORRECTION

Concerning: "'Learn by Experimenting' Beginners' Practical Radio Course, Experiment No. 1." The connections to terminals P and G of the tube should have been reversed, as shown below, in Fig. 2A, pg. 218, Oct. Radio-Craft; Fig. 2B is correct.



GET THE REAL *Inside* FACTS ON TELEVISION

By One of the World's Foremost Television Authorities!

ALREADY COMMERCIAL IN ENGLAND!

On July 17, 1937, the National Resources Committee reported to President Roosevelt that the most important development work in Television was completed, and that only the commercial arrangements remain to be made to provide national Television service. This means that there will be a huge demand for TRAINED TELEVISION MEN! Remember the great shortage of trained men during the early years of radio? Then, the wide-awake men who learned radio and got in on the ground floor reaped rich rewards, and many are leaders in the radio industry, today. Now Television, "the sequel to radio" offers you the same great opportunities. Make Television your stepping-stone to success. TRAINED MEN will earn from \$1,500, \$2,500 to \$20,000 a year.



U. A. SANABRIA
Founder of American Television Institute.



Every student receives this giant television cathode ray tube as part of his equipment.

The American Television Institute

was founded by Mr. U. A. Sanabria, internationally famous inventor of the Interlaced Scanning System, now universally used. The Institute possesses one of the best equipped Television Experimental Laboratories in the world. It is here that men complete their training under the personal supervision of Mr. Sanabria.

Complete "Professional" Television Equipment Included With Each Course

Not small, ordinary instruction equipment, but a full sized "professional" television laboratory used for public exhibitions with a steel rack and panels nearly six feet high, two feet wide and eight inches deep mounted on rubber tired casters; COMPLETE with all parts to make a full-size television transmitter and receiver worth a thousand dollars to one taking this training. ALL OF THIS IS INCLUDED WITH THE A.T.I. COURSE AND IS YOURS TO KEEP. The course is amazingly low in price and on easy terms arranged to suit you. It costs you nothing to thoroughly investigate this opportunity. Don't pass it up! Get into Television! Send coupon NOW!

FREE!

We have compiled, what we believe is, the most interesting and authentic data on Television you've ever read. It's yours FREE for the asking. Gives you real INSIDE FACTS... Technical details... diagrams... illustrations... cathode ray tube construction... Television operation... and hundreds of other important, interesting FACTS. We will send this data without cost or obligation so you may determine how to qualify for entrance into the American Television Institute and how A.T.I. training will benefit you and equip you for a future in radio and television. Clip coupon at right and mail it to us NOW!

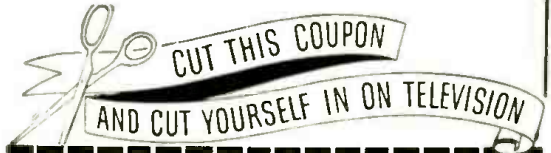

AMERICAN TELEVISION INSTITUTE RC-1237
433 E. Erie St., Chicago, Ill.

Gentlemen: Please send me your free Television literature described on this page. It is understood that all this is free. No obligation.

Name Age

Street

City State

SPECIAL FREE OFFER!

Turn to page 379 of this issue and read all the details about how you can get a FREE COPY of the 1937 Radio Reference Annual.

IF IT'S TOUGH - DON'T CUSS Turn To RADIO-KINK-AIDS

Practical Repairs For Over 3000 Hard-To-Fix Radios.

Just pull out the card corresponding to the name and model of the set you are repairing, and there you have listed the service troubles found in this radio and how to fix them. Yes it's as simple as that.



ONLY \$1.95 COMPLETE WITH METAL CABINET

FREE WRITE FOR BULLETIN AND SAMPLE CARD RC-12
AKRAD PRODUCTS CO.
362 WOOSTER AVE. Akron, O.

Tear out this ad, write your Name and Address in the margin, send \$1.95 and we will send outfit at once.

MIDWEST MOTORIZED TUNING-

TODAY'S radio sensation! Just touch electric button and corresponding station flashes in! (Tune by hand also.) Save up to 50% by ordering this bigger, better, more powerful 20-tube, 6-band radio direct from factory. Pay as little as 50c a week. Write for FREE 1938 catalog.

20 TUBES-6 BANDS

\$49.95 NEW LOW BASE PRICE CHASSIS

MIDWEST Radio Corporation Dept. HH-12, Cincinnati, O.



HYVOL

HIGH-VOLTAGE CAPACITORS



- ★ Handy, inexpensive, oil-filled capacitors for high-voltage filter circuits.
- ★ Compactness due to new exclusive HYVOL—the super-dielectric oil.
- ★ Inverted screw mounting. No larger than usual electrolytic condenser: 1½" dia., either 2¼" or 4½" tall.
- ★ By use of insulating washer, grounded can may be insulated from chassis.
- ★ .5 to 4 mfd. 600, 1000 and 1500 v. D.C. working.
- ★ Conservatively rated. Cool operation. Long life. A lot of capacity for little money.

New Catalog: Big, Startling, 32-page book. Just issued. Ask local supplier or write us for copy, TODAY.



"LET ME TRAIN YOU at home FOR A GOOD RADIO JOB"

Get in Line for Big Money
A. G. Mohaut, Director, Radio is growing fast. Modern receivers require thoroughly trained experts for service and maintenance. You can become such an expert right at home through R.T.A. methods and begin earning money almost from the start of your course. In a very short time you will

Be the ONE Man in 1,000 INCLUDED WITH OUR TRAINING

who understands everything there is to know in order to give quick "sure-fire" service to all kinds of receivers. You can be the one man who can take the service business away from the old-time radio "tinker."

No Experience Needed
Even though you know nothing about radio now, you can quickly qualify the R.T.A. way to step right into a well-paying position—or start your own profitable business. Use your spare time and

LEARN AT HOME
Most R.T.A. members start making money right from the beginning. The special servicing equipment which is supplied without extra cost makes this possible. Don't wait—get started now. Write today for our interesting Radio Book FREE.

Don't Put It Off—Send Coupon Now
RADIO TRAINING ASSOCIATION OF AMERICA
4525 Ravenswood Ave., Dept. RC-712, Chicago, Ill.

RADIO TRAINING ASSN. OF AMERICA
Dept. RC-712, 4525 Ravenswood Ave., Chicago, Ill.
Gentlemen: Send me details of your Enrollment Plan and information on how to learn to make real money in radio quick.

Name

Address

City State



This efficient time-saving, trouble-finding Circuit Analyzer and Resistance Tester helps you to make money without delay. Our Free Book tells you how.

NEW TUBES FOR THE RADIO EXPERIMENTER

(Continued from page 329)

***Ultra-Violet Phototubes:** WL-773, WL-774 and WL-767. These "electric eyes" do what no human eye can do, namely, "see" in the dark! The "trick" lies in peaking the response characteristics of this type of "light"-sensitive cell in the region just beyond the high-frequency limit of human visibility or the ultra-violet range.

Features of the several types: WL-774, tungsten cathode, range of 2,200 to 2,700 A.U., useful in bactericidal field (measuring ultra-violet light used in killing bacteria, preventing mold and in general food preservation); WL-767 (illustrated in Fig. D), titanium cathode, range of 2,700 to 3,200 A.U., useful in measuring erythema (sunburn) and vitamin D irradiation (of milk, for instance); WL-773 (illustrated in Fig. D), thorium cathode, range of 2,700 to 3,600 A.U., useful in measuring vitamin A and in making general ultra-violet measurements.

One of the distinctive features of these phototubes is that they may be used without recourse to shielding the tube from radiations in the visible portion of the spectrum, hence they may be used in direct sunlight, with the knowledge that all of the photoelectric current change is due solely to radiations in the particular ultra-violet portion of the spectrum to which the phototube is sensitive.

The threshold response value is determined by the particular metal used for the cathode and the cut-off value is determined by the type of glass used for the bulb. These characteristics render it unnecessary to use frequency filters.

Optimum response from these tubes requires high input impedance in the amplifier; an electrometer-type tube is ideal. How these tubes shape up in a complete commercial testing unit is illustrated in Fig. E.

Infra-Red, Gas-Type Prong-Base Photocell: Type 923. Because of the high sensitivity of this type cell, which can "see" radiations in the infra-red region quite invisible to the naked eye, it is particularly useful in applications where incandescent lamps are employed as light sources. See Fig. C. Base connections are given in Fig. 1.

Cathode is semi-cylindrical, caesium-coated; anode-supply voltage (max.), 90; anode current, 20 microamperes; sensitivity, 100 microamperes/lumen; cathode window area, 0.43-sq. in. Load resistance, not over 10 megs. This tube is similar electrically and mechanically to the type 918, but has a shorter overall length.

(Data courtesy RCA Radiotron.)

Infra-Red, Gas-Type Cartridge-Base Photocell: Type 921. Substantially identical characteristics to the type 923, but with cartridge-type base like the type 922 photocell. Also, the 921 has a window area of only 0.38-sq. in.; input capacity is 1.1 mmf. Load resistance, not over 10 megs. Base connections in Fig. 1.

(Data courtesy RCA Radiotron.)

Infra-Red, High-Vacuum Type Cartridge-Base Photocell: Type 922. The new double-ended construction (as in the 921) eliminates the conventional base and provides a long insulating

path between electrodes. The terminals at either end are in the form of metallic buttons, so designed as to permit inserting each phototube easily and positively in a clip mounting. The features of this construction are lower cost, low interelectrode capacity (for the 922, 0.6-nmf.), and convenience in circuit arrangement.

Characteristics: cathode, caesium-coated and semi-cylindrical; window, 0.38-sq.-in. Anode-supply voltage, 250 (max.); anode current, 30 microamperes (max.); load resistance, 1 meg.; sensitivity, 20 microamperes/lumen. Light response may be made practically linear for light inputs up to 1 lumen with proper adjustment of supply voltage and load resistance. See Fig. 1 for base connections.

(Data courtesy RCA Radiotron.)

AUDIO POWER TUBE

Beam Power Tube for A.C.-D.C. Radio Sets: Type 6Y6G. The new tube (shown in Fig. D) is intended for use in the output stage of A.C. receivers, particularly those in which the plate voltage for the output stage is relatively low. With 135 V. on the plate and screen-grid it is capable of giving an output of 3.6 W. with a maximum signal input of 13.5 V. Under these conditions the total distortion is about 9.5%. Additional characteristics follow.

- Heater voltage, 6.3 V.; current, 1.25 A.
- Plate voltage, 135, max.; current (zero-signal), 58 ma., and (max. signal), 60 ma.
- Screen-grid voltage, 135 V. (max.); current (zero-signal), 3 ma.
- Control-grid voltage, -13.5 V.
- Transconductance, 7,000 mmhos.
- Load resistance, 2,000 ohms.
- Distortion, 2.5% 2nd harmonic and 9% 3rd.
- Power output, 3.6 W.

Base connections appear in Fig. 1.
(Data courtesy RCA Radiotron.)

TELEVISION RECEIVING TUBE

Cathode-Ray Kinescope (Television Receiving Tube), 5-in. Size; Electromagnetic Deflection: Type 1801. For the first time, experimenters now have available a commercial-built (as compared to the school-built type now being described in *Radio-Craft*) cathode-ray tube specifically designed for television-reception experiments! The screen is of medium-persistence type; the fluorescence color is yellow (phosphor No. 3); max. screen diameter, 5 1/16 ins. This tube is shown pictorially in Fig. B. Base connections are given in Fig. 1. Additional characteristics follow:

- Heater voltage, 2.5; current, 2.1 A.
- Direct interelectrode capacity (control-grid to all other electrodes), 12 (max.) mmf.
- High-voltage electrode (anode No. 2) 3,000 V. (max.)
- Focusing electrode (anode No. 1), 1,000 V. (max.)
- Control electrode (grid), voltage never positive; grid voltage for current cut-off, -35 V. (approx.)
- Fluorescent-screen input power/sq.cm., 10 milliwatts (max.)

Typical operation: heater, 2.5 V.; anode No. 2, 2,000 V.; anode No. 1, 325 V.; control-grid

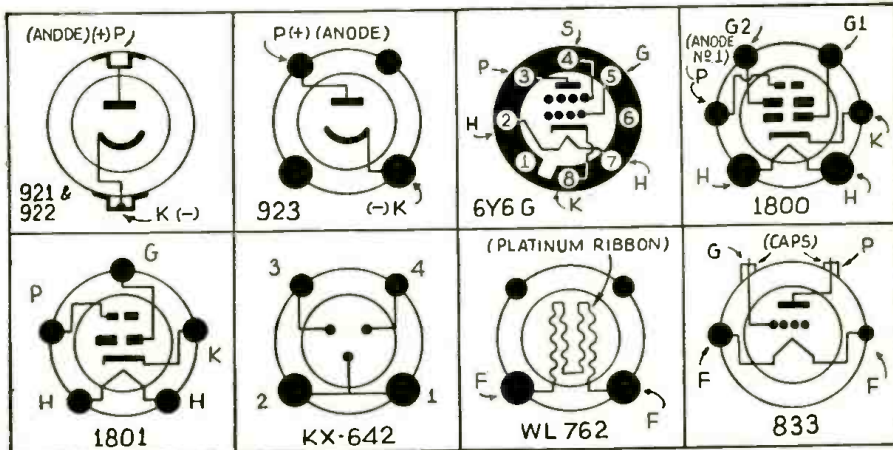

Fig. 1. Underside socket connections of new tubes.

Please Say That You Saw It in RADIO-CRAFT

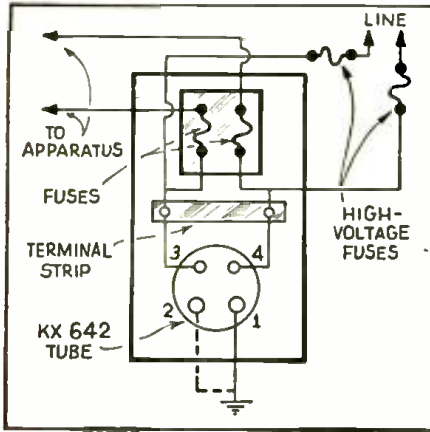

Fig. 2. Circuit for anti-surge tube.

voltage adjusted to give suitable luminous spot; control-grid signal-swing voltage, taking peak-to-peak value for optimum contrast, 15 V. (Data courtesy RCA Radiotron.)

Cathode-Ray Kinescope (Television Receiving Tube), 9-in. Size: Electromagnetic Deflection; Type 1800. Like the type 1801 kinescope this model (shown in Fig. B) has a medium-persistence screen; and phosphor No. 3 (yellow). Base connections are given in Fig. 1; and characteristic data follow:

- Heater, 2.5 V.; 2.1 A.
- Direct interelectrode capacity (grid No. 1 to all other electrodes), 12 mmf. (max.).
- High-voltage electrode (anode No. 2), 7,000 V. (max.).
- Focusing electrode (anode No. 1), 2,000 V. (max.).
- Accelerating electrode (grid No. 2), 250 V. (max.).
- Control electrode (grid No. 1), never pos.
- Grid No. 1 for current cut-off, -75 V. (approx.).
- Fluorescent-screen input power/sq.cm., 10 milliwatts (max.).

Typical operating conditions are available for anode No. 2 voltages of 3,000, 4,500 and 6,000, but since the average experimenter probably will get the 9-in. size tube only with the expectation of getting the maximum possible brilliance in the image, only figures for the voltage will be given here. Heater, 2.5 V.; anode No. 2, 6,000 V.; anode No. 1, 1,250 V.; grid No. 2, 250 V.; grid No. 1, adjusted to give suitable luminous spot; grid No. 1 signal voltage (peak-to-peak value for optimum contrast), 25. (Data courtesy RCA Radiotron.)

SPECIAL-PURPOSE TUBES

*Supervisory Control Protector Tube; Type KX642. Wherever protection against overload is desired, as for instance in radio transmitting stations for switching operations and wherever remote meter readings are taken, as well as in radio service stations as a protection to condensers, transformers, and testing equipment, (Continued on page 383)

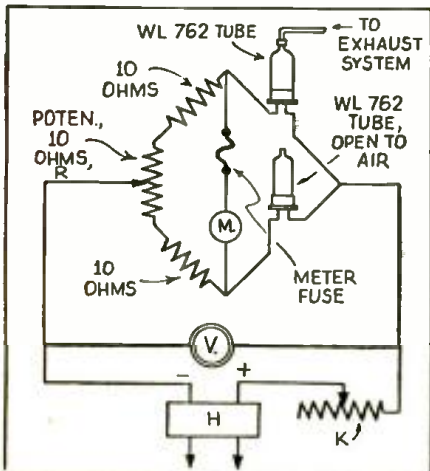

Fig. 3. Bridge circuit for vacuum-test tube.

A TREASURE TROVE

of Free Equipment for
Radio Service Men who buy

NATIONAL UNION TUBES



ASK
YOUR JOBBER
TO SHOW YOU
THIS
GREAT 1938
FREE EQUIPMENT
CATALOG!

80 Big Pages!
More Than 100
Pieces Of —

FREE EQUIPMENT!

Through National Union's help, radio service dealers everywhere have been able to set up better equipped shops to do better work; also to obtain sales helps that produce more customers. National Union has constantly put the latest advances in scientific equip-

ment as well as modern selling aids within reach of the service dealer. The National Union Deal calls for a dealer deposit which is rebated when the specified number of tubes have been purchased. Over 70,000 completed deals. Every dealer should investigate.

NATIONAL UNION RADIO TUBE QUALITY HAS BEEN PROVED IN THE FIELD.

THE ROAD TO BETTER BUSINESS

1. Full guarantee on highest quality radio tubes.
2. Cut price business not solicited.
3. Price Protection.

4. N.U. jobber stocks are complete...No hunting for odd types.
5. Timely business building aids.

NATIONAL UNION RADIO CORPORATION
570 Lexington Avenue, New York City RC-1237

I am interested in the following equipment —

Name

Address

City State



SAVE UP TO 50%

MONEY BACK GUARANTEE!

A complete line of fine quality 1938 models, all electric AC-DC, battery or auto radios. All newest features, beautiful cabinets, 5-12 tubes, at prices that will surprise you. Write for free catalogue. Ask about our money making plan.
ZEPHYR RADIO COMPANY
13141 Hamilton Ave., Detroit, Michigan

ADVANCED HOME STUDY TRAINING FOR "SERVICE MECHANICS" WHO WANT TO BECOME EXPERT SPECIALISTS

Actually it is not a case of WANTING to become a "Service Specialist"—It is a NECESSITY! New developments and changes in circuit designs make it urgent for you to keep pace with the progress of Radio. The serviceman who lacks the necessary training is eliminating himself from a better position and better pay.
START TRAINING NOW FOR THE FUTURE RSI home-study training in Radio Service and Public Address work gives you thorough, basic knowledge of how complex circuits work and what gives into modern receivers. Write today and learn all the facts.

FREE BOOKLET!
You'll want to read every page of "The Key to Successful Servicing." Write at once.

Terms as low as \$5 Monthly

RADIO SERVICE INSTITUTE (Dept. RC-12)

3306-14th St., N. W. Wash., D.C.



**A PERFECT NEEDLE
FOR PERFECT
PLAYBACK!**

Radio Men!
P.A. Technicians!
Sound Engineers!
Broadcast Station Operators!
Use RECOTON playback needles on acetate or regular commercial records with assurance that reproduction is more natural, brilliant and distinct. No loss of higher frequencies—remarkable reduction of scratch and hiss levels. Record life is greatly prolonged because RECOTON superior pianissimo needles are more uniform and have the proper curvature which guarantees "side-wall riding." Each needle plays at least ten records. Illustration above shows method of riding position of the needle in the groove of the record.

Vastly superior to others now in use. RECOTON needles offer additional sales outlets for jobbers and dealers.

Write today for all details—give name of jobber.

RECOTON CORPORATION
178 Prince Street New York, N. Y.

Ask your **JOBBER**
for the NEW

STANCOR
"HAMANUAL"

New Tubes . . . New Circuits
16 NEW TRANSMITTERS
5 WATTS TO 1000 WATTS

STANDARD TRANSFORMER CORPORATION
850 BLACKHAWK STREET, CHICAGO



PHOTOELECTRIC CELLS

A prominent manufacturer has produced this cesium-oxide, 4-prong tube. Experience and production methods assure you a tube of high sensitivity and dependability—maximum working voltage of 90.

Most efficient for use in electronic relays, controls, alarms, speed indicators, automatic counters, plus many other uses.

FREE! A postcard with your name and address brings our new, 32-page 19 37 catalog.

ARROW SALES CO.,
27 S. Jefferson St., Chicago, Ill.

WANTED - MEN

to east Christmas Goods, 5 and 10c Novelties, Toy Autos, Ashtrays, etc. Can be done in any spare room, basement, or garage and no experience necessary. A rare opportunity to devote spare or full time to profitable work. WRITE DEPT. 26.

METAL CAST PRODUCTS CO.

1696 Boston Road New York City

**MODERNIZE YOUR OBSOLETE
TUBE CHECKER OR SET
ANALYZER with "PRECISION"**

Write for details. Mention make and model number of your old instrument.

PRECISION APPARATUS CORP.
1821 EAST NEW YORK AVE., BROOKLYN, N. Y.

HOW DEPENDABLE ARE YOUR METER READINGS?

(Continued from page 340)

increases again slightly at the upper end of the scale.

In view of the foregoing it is always good policy not to take measurements on the 1st 1/5 of the scale, but if possible to choose a range such that the meter pointer deflects to a point just past about the 4/5 region of the scale. Inasmuch as the ratio of most succeeding range steps in multi-range instruments is from 1:2 to 1:10 (i.e., the full-scale value of the next higher range is from 2 to 10 times that of the immediately lower range) the last 1/5 of the meter scale for any particular range is a more accurate place on which to take readings than is the 1st 1/5 to 1/2 portion of the scale on the next higher range.

It should also be remembered that the actual quantitative error in per cent of the measured quantity is lower on this portion of the scale than it is on its preceding 1/5. That is, the error in, let us say, actual volts compared to the total voltage measured, will be less if the range is chosen so that the pointer deflects to a spot past the 4/5 point on the scale than it would be if the next higher range were used (in which case the reading would be thrown into the 1st 1/2 portion of the scale, where the inaccuracy is greater).

OBSERVATIONAL ERRORS

The foregoing applies to inherent meter accuracy. It is also a fact that a given observational error of say 0.005-in. in reading the position of the pointer at a very low part of the scale causes a greater percentage of error in the total reading than the same 0.005-in. error would make in a reading taken at the middle or upper part of the scale. That is, observational errors which may occur have a greater effect on the accuracy of "low-on-the-scale" readings than they do on "high-on-the-scale" readings.

Therefore, because of these particular inherent and observational error characteristics, a safe rule to follow when using a permanent-magnet—movable-iron type instrument is:

If possible, use a range such that the reading will occur past the 4/5 point on scale.

In practice, practically all servicing meters are provided with a sufficient number of overlapping ranges so that at least no measurements need be taken on the 1st 1/5 of the meter's scale. Furthermore, far-thinking meter manufacturers provide their servicing instruments with a number of ranges whose limits have been carefully planned so that a fairly large proportion of the readings usually taken with these instruments on common radio receivers, will fall at or near about 3/4 to 4/5 full-scale deflection (usually the most accurate part of the scale).

Take the usual 7-volt range, for example. This is used most for measuring the filament voltage of tubes having 5- and 6.3-V. filaments. Bias potentials of from 20 to 35 V. constitute the majority of measurements which are taken on the usual 35-V. scale. Line-voltage potentials of from 105 to 125 V. fall in nicely on the 140-V. scale. Plate supply potentials run in the neighborhood of 250 to 300 V.; the 350-V. range is a logical one to measure them on, etc. The scales on a typical modern multi-range meter used in a set analyzer are illustrated in Fig. A. Notice the various scales for the different ranges.

**INHERENT ACCURACY VALUES OF
SERVICING METERS**

It is common practice for instrument manufacturers to make good-grade permanent-magnet movable-coil type D.C. meters (of the types used in Radio Service work) with an inherent accuracy to within 2% of full-scale value (for any range). This does not mean that the inaccuracy will necessarily be as large as this all over the scale—it merely means that the inaccuracy will not exceed this value.

Most A.C. rectifier-type meters of good grade are usually accurate to within only 5% on their A.C. ranges, due to variations in the resistance of the rectifier, temperature, humidity, etc. When used for D.C. measurements, they may be expected to read accurate to within 2% of full-scale value. It must be mentioned here that inherent accuracies as high as this should not be expected in very low-priced meters of shoddy construction, in meters which have been abused, or in meters subjected to abnormal temperature or humidity conditions.

**WHAT IS MEANT BY THE TERM
"METER ACCURACY"?**

There are 2 possible ways to state the inherent accuracy (or inaccuracy) of an electrical indicating instrument. They are:

- (1) The maximum likely error could be stated as a percentage of the individual indication.
- (2) The maximum error can be stated as a percentage of the full-scale value of the meter range under consideration.

Let us see which of these is in common use—and why! At first thought, it would appear that the first method would be preferable, for the instrument user is interested in the accuracy (or inaccuracy) of the individual measurement he is making. Therefore, if the error figure were given to him in per cent of the actual meter indication, he would have just the information he wants. However, if this method of expressing the inaccuracy were employed, no single inaccuracy figure would give a true picture of the inaccuracy of the instrument for the entire range of the scale: for, as we have already seen, the inherent inaccuracy of any instrument varies widely at different parts of its scale.

For instance, it can be seen from the graph of Fig. 4 that the figure expressing the inaccuracy at the 1-V. point on the scale would be different (and very much higher) than that expressing the inaccuracy at the 6-V. point, etc. Consequently, if this method of expressing inherent meter inaccuracy were employed, information concerning the value of inaccuracy which exists at almost every meter division, would have to be furnished in either graph or tabular form by the instrument manufacturer in order to make the accuracy information at all complete. Obviously, this would be impractical for popular-priced instruments, since it would require complete accurate calibration of the scale for each range, plotting of a graph for each range, etc.

One alternative would be for the manufacturer to state the inaccuracy which exists at the most inaccurate part of the scale, and specify this as the maximum possible inaccuracy that would occur in readings taken at any point on the scale. This would not be fair to the manufacturer and his instrument however, for the most inaccurate part of the scale is usually at the extreme lower end (which is not used much), and the inaccuracy which exists over this small portion of the scale is very much greater than that which exists over all the rest of the scale (see Fig. 4). Since this highest value of inaccuracy would have to be the one specified for the entire instrument, the manufacturer would be penalizing his instrument by attaching to it a high stated inaccuracy value which really only exists at a very limited portion of the scale—a portion which is very seldom used anyway.

The foregoing point may be clarified by reference to the instrument considered in the graph of Fig. 4. The inaccuracy at the 1-V. point on the scale is actually about 0.18-V., or 18% of the indicated value; whereas over the whole portion between about 4 and 10 V. on the scale (more than 1/2 of the total scale), the inaccuracy does not exceed even 0.7% at any point. Therefore, if the foregoing method of expressing meter accuracy were used, the manufacturer of this particular meter would have to state that his meter was 18% inaccurate. Obviously such a high inaccuracy rating would be detrimental to its sale. It would also be most unfair, because actually, over practically the upper 60% of its scale (the very part that would be used most) no indicated reading would be in error by more than 0.7%, and even over the next lower 20% of the scale, the errors would all be under 6%!

Part IV, concluding this series, will discuss all the "Don'ts" in connection with the proper handling of test meters and equipment. A few comments concerning your reaction to this article, so far, would be appreciated by the author, and by the editors of Radio-Craft.

The author of this vital article is also author of "Radio Physics Course," "Modern Radio Servicing," and "Radio Field Service Data"—all of them valuable contributions to the field of literature for the practicing radio Service Man.

Trains in the far south of Argentina (corresponding to Canada's far Northwest in climate) will be equipped with radio to keep them in touch with divisional headquarters.

Better - Quicker - More Profitable Servicing with RADIO CHASSIS CRADLE



Service shops need the RADIO CHASSIS CRADLE for efficient servicing of testing and repairing of receivers or amplifiers. Equipment clamps to cradle which can be adjusted to any angle. Accommodates chassis up to 13 x 12 x 23 inches. Excellent for displaying receivers. Write for illustrated circular RCT

WM. A. THOMAS CO. 321 CAROLINE ST., NEENAH, WISCONSIN

RADIO ENGINEERING

RCA Institutes offer an intensive course of high standard embracing all phases of radio. Practical training with modern equipment at New York and Chicago schools. Also specialized courses and Home Study Courses under "No obligation" plan. Catalog Dept. RT-37.

RCA INSTITUTES, Inc.
A Radio Corporation of America Service
75 Varick St., New York 1154 Merchandise Mart, Chicago

BUILD IT YOURSELF

You can build this Trailer with ordinary tools easily from our step-by-step constructional sheets and large sized blueprints. Finest designed Trailer in existence, sleeps 4. Toilet. Shower. Electric Light, etc. Save 75% of the cost by building it yourself. Send 25c for plan sheet, illustrations and details.
THE PLAN SHOP, 910 Palmolive Bldg., Chicago, Ill.

RADIOS..SAVE UP TO 50%

DEAL DIRECT...FACTORY PRICES! Many models to select from: AC-DC; All-Wave; armchair models; automatic tuning; car radios; Farm sets that operate like city radios! Send Postcard for NEW Bargain Catalog FREE. 30-DAY TRIAL plan and advertisement proposition!
GOLDENTONE RADIO CO. DEPT. B12, DEARBORN, MICHIGAN

RADIO IN ITS ENTIRETY!

"B-A" serves the trade with every need in radio—complete 160-page catalog of nationally known radio receivers. Public address, parts, batteries and equipment. Orders shipped same day received.
COMPLETE CATALOG AVAILABLE
BURSTEIN-APPLEBEE CO. 1922-14 McGEE ST. KANSAS CITY, MO.

FREE POST CARDS MAY BE HAD UPON WRITING TO THE PUBLISHERS

These post cards make it easy to answer advertisements which appear in *Radio-Craft*. Without cutting valuable data which you may wish to save. So send for a supply of free post cards and use them in answering all *Radio-Craft* advertisers.

JOIN

AT THE HELM - in time of need

RECENT APPLICATIONS OF THE "ELECTRIC EYE"

(Continued from page 349)

at which the reaction is complete (or half-complete) after the fluids have been mixed may be found, provided that the reaction, even at top speeds of flow, is not too fast to be measured.

Millikan Method. G. A. Millikan has constructed a micro-apparatus (Fig. 3C) on the same principle. He uses the differential photocell already described. This method, more than any other, has advanced our knowledge of rapid chemical processes. For instance, we know now how quickly our blood pigment combines with oxygen or with the poisonous carbon monoxide:

Under the conditions of these experiments the combination of the blood pigment with oxygen is half-complete within 1/100-second, whereas the reaction with carbon monoxide takes somewhat longer. It is clear that only such reactions can be studied by means of the photometer which involve color changes.

If colorless fluids are studied, the photometer is replaced by a sensitive *thermopile* which will pick up temperature changes of as little as 1/1,000-deg. Centigrade. Since every reaction is accompanied by smaller or larger temperature changes, this extends the range of the method to practically every fast process worthy of investigation.

A Recording Reaction Meter. Recently an apparatus has been developed by Stern and DuBois which may cover the gap between the range of the very fast reactions suitable for study with the flow method and the range of much slower changes which may conveniently be followed by the classical methods of chemistry. This is the principle:

One reaction partner is placed in the absorption cell (Fig. 3D) which is put in the path of *monochromatic light* before it strikes the photocell (vacuum or gas-filled caesium cell). The photoelectric current is amplified by an electron tube circuit (Fig. 4) and measured by a string galvanometer. Its deflections are recorded on a strip of photographic paper. Every 20th of a second a pin on an electrically-driven wheel, controlled by a tuning fork, sweeps across the slit of the camera and makes a time mark on the film.

The reaction is started by injecting the second reaction partner by means of a spring gun (Fig. 3E) into the stationary fluid. Mixing is complete in about 1/100-second. A color change due to a chemical reaction affects the light falling on the photocell and is consequently recorded on the film. The photocell is calibrated with the aid of the rotating sector indicated in Fig. 3D. Some typical records obtained with this method are shown in Fig. 5. The upper curve represents a straight mixing process (a dye was injected into water) and the lower curve a reaction of a blood pigment with peroxide in the course of a catalysis. By varying the speed of film transport a wide range of reaction rates may be covered.

In concluding this brief survey it may be said that we can expect from the photoelectric cell an ever increasing usefulness in its service to mankind.

"SNOW STATIC" BEING BEATEN BY "FLYING LABORATORY"

(Continued from page 348)

the receiver is caused by the random variation of the discharge flow rather than the total discharge.

Whenever the discharge from the steel point or antenna exceeded a certain rather broad maximum, the characteristic snow static sounds were heard in the radio set.

A series of points (LR, in one of the photos) were installed on the plane to learn the distribution of this discharge. These were arranged on the nose, tail, each wing, behind the exhaust outlet, behind the propeller, and at 4 points along the plane belly. The points were connected in a number of group arrangements to vacuum-tube electrometers. The electrometers were in turn connected to paper recorders. Recordings were made in a variety of cloud formations over a period of 8 weeks. It is of interest to note that at a speed of 180 miles an hour the variation in charge on the plane is so rapid that automatic recording devices are the only means by which a useable record can be obtained. (Be sure to read Part III, next month.)

Please Say That You Saw It in RADIO-CRAFT

POCKET SIZE... YET Precise!

WESTON Model 697 VOLT-OHM-MILLIAMMETER



ONLY \$28⁸⁰

NET IN U. S. A.

Here's a convenient, *pocket-size* radio test instrument... but one that is made to the same standards of accuracy and dependability as the larger WESTON instruments. *Nothing has been sacrificed to achieve this small size.* The ranges provided, too, are complete for radio servicing:

Voltage Ranges: AC and DC—0-7.5; 0-15; 0-150; 0-750

Current Ranges: DC only 0-7.5 and 0-75 milliamperes

Resistance Ranges: 5000-500,000 ohms full scale; 35-3500 ohms center scale

Size: 5 1/8" x 3 3/4" x 3 1/8"

Model 697 is a most convenient tester to carry on service calls... a cinch to handle on the bench or around the shop... yet it is extremely low-priced for a sturdy, dependable WESTON instrument. Model 697 and other pocket-size WESTON testers should be included in every serviceman's kit. Be sure you have full information. Return the coupon today.

WESTON Instruments

Weston Electrical Instrument Corporation
599 Frelinghuysen Ave., Newark, N. J.
Send complete information on Pocket Size Testers.

Name _____
Address _____
City _____ State _____

"DEPEND ON DEPENDABLE"

greater **ACCURACY**
wider **TESTING RANGE**
lower **COST**

DEPENDABLE MODEL 409
AC-DC MULTITESTER

5" Fan Type D'Arsonval meter • Accuracy 2% • Separate low ohmmeter scales • 4 ohmmeter ranges (no external batteries) • High range 7,500,000 ohms • Low range center of scale 2 ohms • Each of first 10 divisions reads 1/20 ohm • Low current drain • Used on A.C. and D.C.—25 and 60 cycle • A.C. voltages as accurate at 20,000 cycles as at 60 cycles • No frequency, wave form or temperature error in rectifier • Linear A.C. voltage scale • 2000 ohms per volt • 5 D.C. current scales include microamps, amps, A.C. and D.C. volts—0.5-50-500-1000, D.C. microamps—0-500 D.C. Milliamps—0.5-50-500, D.C. amps—0-5, Ohms—9,100-7500-75,000-7,500,000. Power level in decibels from -9 to +40.



\$17.95

See your jobber. Write to Dept. C. for catalog. Write for particulars on new deluxe tube tester Model 311

RADIO CITY PRODUCTS CO.
88 PARK PLACE NEW YORK CITY

Get Smart!
USE THESE NEW SERVICE SHORT CUTS

HOME RADIO TROUBLE SHOOTER
SPEED UP YOUR SERVICE WORK with these amazing new pocket-size radio. TROUBLE SHOOTER "GADGETS" that instantly tell you exactly where to find the defect in any "stick" radio set by the "Trouble Symptom" method.

TWIN "TROUBLE SHOOTERS"
worth weeks of pay!

Just take up your Gadget, pick out the eyeletted card marked for the particular Trouble Symptom you find; flip the card around, and there you'll see all the possible Causes for the particular trouble. The exact Tests to make and the Remedies to apply. Works quick as a flash—almost like magic! Gets you right to the trouble in a jiffy, without "fussing" around. One for HOME RADIOS, each one "spots" over 400 different set troubles. Sent postpaid anywhere on 5-day TRIAL.

AUTO RADIO TROUBLE SHOOTER

MAIL NOW!
\$1 FOR THE PAIR

RADIO & TECHNICAL PUBL. CO., Dept. RC-127, 45 Astor Pl., New York
Money Back Guarantee

DON'T!
BUY ANY AMPLIFIER OR PUBLIC ADDRESS SYSTEM until you read our bulletin describing a new line of 1938 amplifiers designed by A. C. Shaney featuring:
Audio Spectrum Control
Cathode-Drive Amplification
Automatic Feedback Suppression
F.V.F.B. Beam Power Amplification
Automatic Audio Volume Control
Floating Audio Power
Plus many other exclusive features.
Our Amazingly Low Prices, Free Trial Offer, and Usual Five Year Guarantee Make it Well Worth Your While to Write To-Day for Free Bulletin No. PA 1237. Free P.A. Consulting Service.
AMPLIFIER CO. OF AMERICA
37-47 West 20th St., New York, N. Y.

Learn SOUND RECORDING TALKING PICTURE PROJECTION TELEVISION-RADIO

Master training courses qualify you for good jobs. Excellent, easy to learn, newest equipment. Established 1905. Earn room and board while learning. Coach H. B. Spill allowed in P.A. Write for FREE BOOK. Address Dept. 1237, 4000 S. Figueroa St.

NATIONAL SCHOOLS - Los Angeles

"LEARN-BY-EXPERIMENTING" BEGINNERS' PRACTICAL RADIO COURSE

THE POWER SUPPLY AND HOW IT WORKS

(Continued from page 343)

This is accomplished in the type 80 rectifying tube, which has the property of allowing current to pass through it in only one direction.

This tube has a filament which is heated by another low-voltage secondary winding (that makes 3 secondary windings in all) supplying it with 5 V. A.C. and it also contains 2 plates. If only 1 plate were present, it would be called a half-wave rectifier and would allow only the positive half of the A.C. cycle to pass through, suppressing the other half. Since the type 80 tube contains 2 plates, it is called a full-wave rectifier, and these plates are so connected that each half of the cycle is allowed to pass through in the same direction, thus giving the type of direct current shown in Fig. 1C where the amount of current varies rapidly, but does not at any time fall below the zero line. This "unidirectional" (1-direction) output therefore is a surging or pulsating D.C.

"FILTERING"

For the 3rd part, "filtering," it is necessary to remove the pulsations from the rectified D.C. so that the radio tube plate may be supplied with an unchanging D.C. This is accomplished by an arrangement of iron-core coils (known as chokes), and condensers of high capacity (which in this case, are electrolytic condensers). The choke coil freely allows steady current to pass through it, but offers opposition to current in which changes (pulsations) are taking place. The high capacity condensers, meanwhile, are charging with every increase in current, and discharging with every decrease in current, with the result that the condensers store the charge when it tends to be excessive, and deliver their charge to the line when it tends to drop to zero. This, in effect, is a stabilizing action and also tends to keep the current from varying. Thus, by using a combination of choke coil and its associated condensers, we impede the pulsations of current with the choke coil and deliver these pulsations to a condenser which smooths the pulsations by its storage action. Such a combination is therefore known as a "filter section". (In our arrangement, since the rectifier feeds directly into a condenser, we have what is known as a condenser-input filter.) Thus, by passing the pulsating D.C. through 2 filter sections (as shown by the 2 choke coils present), we obtain a practically pure D.C. output, which is pictured in Fig. 1D.

FUNCTION OF OTHER PARTS

To make our power supply suitable for the many purposes of various experiments, we provide a means of varying the "B" voltage over a wide range. This is done by an arrangement of resistors, forming a voltage divider.

Resistor R1 is connected in series with potentiometer P1, and the combination is connected across the output terminals (marked "B+Hi" and "B-", in Fig. 2E). In this way the full voltage is impressed on the combination and a slight current (known as the bleeder current) flows through it, exerting a steadying effect on the system.

The moving arm of potentiometer P1 can then be varied to include as much of the full voltage as is desired up to the junction of R1 and P1, which would then include about 2/3 of the total voltage (or usually, under ordinary loads), about 250 V. Thus with the use of the 2 "B+" binding posts, we may use both the full voltage (usually, under ordinary load), about 375 V. directly from the "B+Hi" (High) binding post, and the variable voltage from the "B+Var." (Variable) binding post, which may be used at the same time to give from zero to about 250 V., by turning the dial-knob of P1.

To see what types of current are present in different parts of the circuit, we will use a testing system. The most direct method would be to use a device known as an oscilloscope, which can make the 3 types of current directly visible in the form of characteristic curves shown in Fig. 1, Sections B, C, and D. However, since such a cathode-ray oscilloscope, while extremely useful, is yet a bit too advanced and relatively expensive

PYRO PANTAGRAPH



Size of box: 12 1/2 x 18 1/2 inches

\$2.75

Shipping weight, 3 lbs.

VOGUE This electrical outfit is especially designed for burning designs permanently on materials such as Leather, Wood, Cork, Bakelite, etc. Plug the Pyro-electric pencil in any 110 volt AC or DC outlet and it is ready to be used. Plug and cord furnished.

By the use of the Pantagraph included in the outfit, any design may be reproduced either in original, reduced or enlarged form.

Outfit consists of: one Pyro-electric Pencil; one Pantagraph; three hardwood plaques; one bottle of Varnish; one Brush; one tracing tip and four-page instruction sheet.

Size of box: 12 1/2 x 8 1/2 inches.

Outfit will be forwarded by Express Collect if not sufficient postage included with your order.

WELLWORTH TRADING CO.
558 W. Washington Blvd., Dept. RC-1237, Chicago, Ill.

Your Opportunity Now Comes . . .

GADGETS
200 PICTURES
HOW TO USE THIS ISSUE
REGULAR DEPARTMENTS
THE MONTH'S LATEST GADGETS
MOST GADGET PATENTS
HOW TO MAKE YOUR OWN GADGETS

Over 150 New Gadgets
25c

to know about latest gadgets—add gadgets which work for you—add to your pleasure. Laugh at the "Goofy Gadgets" office. Read about the Patent Office. Read about the firm selling the newest gadget patents. Learn to make your own gadgets—study the newest gadget patents. OVER 150 NEW GADGETS ILLUSTRATED IN THIS BIG ISSUE! On all newsstands, or send 25c in coin or stamps to NEW IDEAS, 99-R HUDSON STREET, NEW YORK, N. Y.

ON ALL NEWSSTANDS

Please Say That You Saw It in RADIO-CRAFT



... Men!

HERE IS THE MODERN MIRACLE WATER PEN —

WHEREVER there's water, there's ink—for the MIRACLE WATER PEN. There's a tiny ink cartridge in the barrel of the pen—two or three lifts of the suction lever and the pen is completely filled. One small ink cartridge keeps this modern pen supplied with ink for many months.

All parts of MIRACLE WATER PEN are acid "corrosion" proof. Nibs are 14-karat gold-plated. Air-tight inner cap keeps pen moist at all times. The ordinary fluid capacity is almost twice other pens. Five additional ink cartridges are carefully hidden in a reserve chamber. MIRACLE WATER PENS carry a life-time guarantee.

Order your MIRACLE WATER PEN today—by mail. Sent POST-PAID anywhere in United States upon receipt of check, money order or cash for \$1.50. Regular \$4.00 value.

ONLY \$1.50

GREN PARK COMPANY
1229 Park Row Bldg., New York, N. Y.

GREN PARK COMPANY RC-1237
1229 Park Row Bldg., New York, N. Y.
Gentlemen: Enclosed you will find my remittance of \$..... for which send me..... MIRACLE WATER PENS at One Dollar and Fifty Cents (\$1.50) each. YOU ARE TO SEND ME THE PEN POSTAGE PREPAID.

Name

Address

City State

(Send remittance by check, money order, unused U. S. Postage Stamps. Register letter if you send cash with order.)

for use here, we will instead use an indirect method for obtaining the results needed for this Experiment, in an inexpensive manner.

This is accomplished by causing the current simultaneously to give visual effects on a neon tube and audible effects on a loudspeaker. By utilizing the property of the neon tube, which lights on only one plate with D.C., and lights on both plates with A.C. we can visually determine whether A.C. or D.C. is present; and by listening to the loudspeaker, we can tell whether the current is varying or constant by the presence of any audible hum, since any changing current, whether A.C. or D.C., will cause a hum; while pure D.C. will not give any perceptible hum. This testing system, shown in Fig. 2, Sections A, B and C, is arranged so that no more than 2/3 of the total voltage is ever impressed on the neon tube—loudspeaker combination to avoid any possible damage to the test equipment because of excessive voltage.

THE EXPERIMENT—POWER SUPPLY

OBJECT: To construct and study a power supply operated from the alternating current line socket.

PROCEDURE AND RESULTS

(1A) *Construction*—The layout of parts is shown in assembled form in a top view in Fig. B and in a bottom view in Fig. C. Here it will be found very practical to use a chassis which has the large openings already punched in it for P.T., S, and the binding post strip. All other parts are easily mounted by drilling small holes.

As a matter of convenience, the 3 electrolytic condensers, C1, C2, and C3, placed side by side, are first attached to a soldering lug strip at each end and the 2 lug strips are then easily mounted with screws. The precaution of connecting condenser lead, marked +, to the positive side of the circuit must be observed here. And the ever-present precaution that, when working with a metal chassis, no exposed connections touch the chassis also applies here. As to those connections which are intended to be grounded (which in this case means only the connecting to the chassis), all of these chassis connections should be electrically bonded, that is, connected together at a common point.

The wiring is shown in symbol form in Fig. 1E. NOTE: Do not complete the wiring of points D, E and "B+Hi" (shown as dash lines in the schematic diagram), as they will be used for test purposes later. Instead attach a length of wire ending in a spring-clip to point E, as shown in Fig. 1E and leave points D and "B+Hi" unconnected. These points will be permanently connected later as we proceed with the testing. For the same reason, bring out an extra wire from point P and another wire from point F of the tube socket, and make a temporary connection of 2 extra wires (preferably of different colors) to the 2 temporarily unused connections on the binding post strip. These extra wires will also be taken care of, as we proceed with the testing, so that they will not appear in the completed unit.

When the wiring is ready for testing, then, there should be 1 testing wire, ending in a spring clip labeled E and 2 temporary testing terminals, labeled P and F. These binding post strip terminals are best labeled immediately by pasting narrow strips of gummed labels beneath them and properly marking the strips.

(1B) *Method of Handling High Voltage*—Before the power plug is inserted into the line socket, it is imperative that we have a definite method for going about our tests without incurring any shock. This method is simple and safe and calls for remembering just 2 rules, namely:

Rule 1. Turn off the power before touching any part of the power supply IN EVERY CASE!

Rule 2. With the power off, try to make connection WITH ONE HAND, keeping the other hand free from any contact with the power supply whatsoever!

Note that the condensers retain their charge for a short time, even after the power is turned off, until the charge leaks off through the "resistance load". To simply correct this condition, touch the bare ends of a short length of wire, held by the insulation, to the "B+V" and "B-" posts, after the power is turned off, thus completely removing any charge that may be stored in the high-capacity condensers.

(2) *Testing the Current Delivered by the Power Transformer*—Referring to the testing system, Fig. 2, it will be seen that we are using the full resistance of R1 and P1 as the load. The lower end of this full resistance is already connected to "B-" internally, and for the other end

(Continued on following page)

The world's largest Exclusive Radio Tube Manufacturers!

ALL the resources of the vast Raytheon organization are concentrated in the development and production of radio tubes! Raytheon is an organization of specialists. All the brains, time and effort are expended toward one end—that you may have better quality, longer-lasting radio tubes.

This unusual policy is responsible for some of the greatest developments in tube design: The universally used auto-set filamentless gaseous rectifier—the OZ4—is one of the fruits of Raytheon concentration. The Beam-Power output tube is another important Raytheon contribution.

There have been many others since the famous Raytheon "BH" and "BA" tubes years ago which began the era of all-electric receivers.

Raytheon service is comparable to Raytheon quality. There is an outstanding Raytheon jobber in every community to supply you promptly. He stocks the most complete line of tubes made today.

Order Raytheon for greater permanent tube profits!

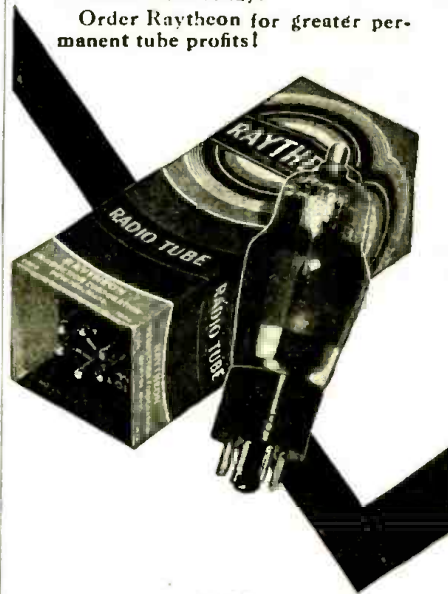

RAYTHEON

445 Lake Shore Drive, Chicago, Illinois
555 Howard St., San Francisco, Cal.
420 Lexington Ave., New York, N. Y.
55 Chapel Street, Newton, Mass.
415 Peachtree St., N. E., Atlanta, Ga.

FOR BETTER RECEPTION

Please Say That You Saw It in RADIO-CRAFT

MILLION TUBE TESTER



FEATURES

- Emission
- Metal Tubes
- Shorts Hot
- Leakage Hot
- Resistance
- Electrolytics
- By-Pass
- Condensers
- D'Arsonval Meter

MODEL CP \$13.95 NET

MODEL TM \$16.95 Has 3" square meter and continuous line voltage adjustment.

Direct orders require deposit and name of your jobber.

MILLION RADIO AND TELEVISION LABORATORIES
559 N. UNION ST., CHICAGO, ILL.

SPECIAL RADIO OFFER

IMPERIAL EASY-TO-BUILD RADIO KIT



All parts mounted ready to wire up and plug in. Complete (less tubes) with necessary fittings, supplies, simple directions furnished with kit. The thrill of a lifetime—so easy even a child can assemble this new type 5 tube radio. Operates on A.C. or D.C., 115 volts. Your individual radio at a fraction of what you'd have to pay at any store.

545

ADD ONLY 25c POSTAGE

Vol. control with switch, 25,000 ohms .5c ea.
Resistors (carbon) 1/2, 1, 2, 5, 10, 20, 50 ohms .1c ea.
Dynamic speakers, 3000 ohms, 7" tube set, all ready drilled .35c ea.
Knobs .10c ea.
Cords .15c ea.

Parts for 5-tube A.C. P.C. set .10c ea.
Paper condenser .01, 400 Volts .10c ea.
Paper condenser .1, 200 Volts .10c ea.
Block capacitors (electrolytic) 16-16-8-5-5 P.V. 175 .50c ea.
Plate condenser 00036, 2-gang .75c ea.
Aerial kit complete \$1.00 ea.

All orders under \$1.00, add 15c postage; west of Miss. add 20c. Orders over \$1.00, add 20c; west of Miss. add 25c. Foreign and U.S. possessions, under \$1.00, add 25c; over \$1.00, add 25c. Send 2c stamp for catalog.

IMPERIAL MODEL AERO SUPPLY
416R McDONALD AVENUE, BROOKLYN, N. Y.

LEARN AT HOME — ONLY \$1 A MO.

RADIO ELECTRICAL ENGINEERING

RADIO ENGINEERING Extra Fine course in Radio. Public Address, Photo-Electric Work. Train yourself to be super-service man, real vacuum tube technician. Unusually thorough for the very Low Price!

ELECTRICAL ENGINEERING Get good grasp of wide electrical field. Prepare yourself at Low Cost, for secure future. Modern. Simplified. Quickly understood.

ONLY \$25! Either course. Deferred payment plan. Experimental kits furnished. Diploma given on completion.

FREE! Send quick for free copies of school catalogs, student magazine, complete details. Don't enroll anywhere before seeing our literature. **WRITE NOW!**

LINCOLN ENGINEERING SCHOOL, Box 931-52, Lincoln, Nebr



"HAM" SPECIAL Standard Telegraph

A highly efficient code teacher using heavy specially prepared waxed paper tape, having two rows of perforations. Write for Free folder A-12. We are the originators of this type instrument

Instrument with tapes prepared by expert and complete course: all for \$11.95. Without Oscillator. **72-76 Cortlandt St., N. Y. C.**

TELEPLEX CO.

Practical electricians

FOR EVERYBODY — PASTIME OR PROFIT

Clearly written, fully illustrated. Chock full of ideas. Easily understood—easily made.

Write for free circular today!
AUTOPower, 409 S. Hoyne Ave., Chicago

(Continued from preceding page)

we use the clip attached to point E (which is the upper end) and attach this to whatever point in the circuit we wish to test. The neon tube and loudspeaker are connected in series, and the ends of this combination are connected to "B-" and "B+Var." (variable) posts, with the variable arm set at maximum (100 on the dial reading).

For testing the current from the power transformer, the clip from point E is clipped on to temporary terminal P (coming from the P of the tube socket), thus placing our testing system across 1/2 the high-voltage secondary of the power transformer.

TABLE OF DATA
(Students, fill in your results.)

Current From:	Power Transformer	Rectifier	Filter	"B+ Variable"
Type of Current				
Hum: (loud, soft or negligible)				
Lighting of Neon: (one or both plates)				

Turn the power on with the switch. As the 80 tube heats up, results should be evident from the neon tube and from the loudspeaker. Obtain the results called for in the Table of Data, namely, the lighting of one or both plates of the neon lamp to indicate whether the current is A.C. or D.C.; and the amount of hum from the loudspeaker, observing whether loud, soft or negligible. Also make a mental note of the pitch of the hum.

Turn the power off, and use the discharging wire to remove any possible condenser charge by holding the wire by the insulation and touching its bare ends to the "B-" and "B+Var." binding posts. Although there will probably be no sign of any charge (since the high-capacity condensers are still unconnected) it is best to do this, as a matter of habit, every time the power is turned off.

(3) *Testing the Current from the Rectifier*—With the power off, remove the spring clip E from temporary screw terminal P, and clip it on to temporary screw terminal F (coming from the F of the tube socket). Turn on the power, and again note, for recording in the Table of Data, the lighting of the neon lamp and the sound from the loudspeaker. Also try to compare the pitch of the sound with the remembered pitch in the preceding test. Most ears should be able to determine by remembering whether this pitch is higher or lower, since the frequency of one will be twice the other.

Turn off the power and again "short" terminal "B-" to "B+Var."

(4) *Testing the Current from the Filter*—At this point, the permanent connections are made. Remove, by clipping off, the extra wires from the P and F terminals of the tube socket. Remove the clip E and make a permanent connection between E and the point marked "B+Hi", which

Astounding

but it is a fact!

The GERNSBACK OFFICIAL RADIO SERVICE MANUALS

(Volume 1 through 6)

Contains Over 13,000 Service Diagrams

IN 1931 the first Gernsback OFFICIAL RADIO SERVICE MANUAL was published—each successive year a new volume appeared. Today over 87,000 OFFICIAL RADIO SERVICE MANUALS are being constantly used by radio Service Men.

Every edition of the Manual is an encyclopedia of schematic diagrams. The first six volumes contain over 13,000 wiring diagrams. Rarely comes a set for servicing for which you can't find the diagram and service information you need. Diagrams for sets which were distributed in 1927—and many marketed prior to that date—are published in Gernsback Manuals.

Here is a complete listing of all the Gernsback OFFICIAL RADIO SERVICE MANUALS, including the two volumes of the OFFICIAL AUTO-RADIO SERVICE MANUALS.

- 1936 MANUAL Over 1,200 Pages—Over 2,500 Illustrations—\$7.00
- 1935 MANUAL Over 1,000 Pages—Over 3,000 Illustrations—\$7.00
- 1934 MANUAL Over 400 Pages—Over 2,000 Illustrations—\$3.50
- 1933 MANUAL Over 700 Pages—Over 2,000 Illustrations—\$5.00
- 1932 MANUAL Over 1,000 Pages—Over 2,000 Illustrations—\$5.00
- 1931 MANUAL Over 650 Pages—Over 1,500 Illustrations—\$4.50
- 1933 AUTO-MANUAL Over 240 Pages—Over 500 Illustrations—\$2.50
- 1935 AUTO-MANUAL Over 240 Pages—Over 500 Illustrations—\$2.50

Any of these Manuals can be ordered by filling in coupon below—and mailing it with your remittance to **RADCRAFT PUBLICATIONS, Inc., 99 Hudson Street, New York, N. Y.**



MAIL COUPON TODAY!

RADCRAFT PUBLICATIONS, Inc.
99 Hudson St., New York, N. Y.

Gentlemen: Enclosed find my remittance of \$..... for which send me **POSTPAID** (one copy of the OFFICIAL RADIO SERVICE MANUAL. (Send remittance by check or money order. Register letter if you send cash.) This offer is good only in U. S.

Name

Address

City State

**GET THIS new BOOK—
FREE!**

Every Radio Man Can Use
It to Advantage!

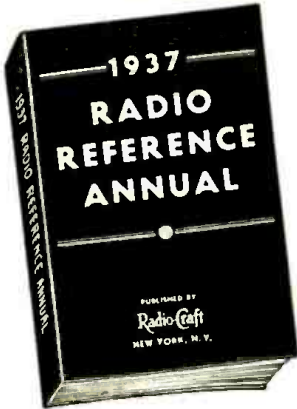

THE Editors of RADIO-CRAFT have prepared a special book for you. The new book—1937 **RADIO REFERENCE ANNUAL**—is not for sale, but available only to subscribers, both new and old, with a Seven Months' Subscription to RADIO-CRAFT. The price of this Special Offer is only One Dollar (\$1.00)—and as an additional saving the book is mailed to you **postpaid** as well as is the magazine each month. Carefully outlined below is the contents of this new book; it contains information which every radio man needs. The book contains 64 pages, size 6 x 9, and is replete with illustrations.

Read these Interesting Chapter Headings of
1937 RADIO REFERENCE ANNUAL

Receiver Construction

Building a 12-tube All-Wave DX receiver—How to make a modern 6-tube Car Radio set—building up a 2-tube Beginner's Set, with several different power supplies for various uses—Constructing a 2-tube midset set for portable use—How to build a "talking" briefcase—no aerial or ground needed.

Test Equipment—Construction

How to make an "Electronic Eye" output meter—How to construct an ultra-compact universal Volt-Ohm-Milliammeter—How to make a Resistance-Capacity tester—How to build a Pocket Adapter for set testing—Building a Portable Capacity bridge—Construction of a V.T. Voltmeter in compact form—How to Make a Modern Set Analyzer.

Audio and P. A. Equipment

Making an Audio Bass Booster, using direct coupling—How to build and add a Dual-Channel Amplifier to your receiver—Constructing a High-Fidelity Amplifier—Construction of a 3-tube A.C.-operated Pre-amplifier—Fundamentals of "Deebel Level" and "Deebel Gain."

Articles for the Service Man

Servicing with the Oscilloscope—Servicing with a Single Meter—"What's Wrong With Your Radio?" chart—Tapers of Volume Controls, and use of various types—Ideas for the Service Shop—Aligning All-Wave receivers.

Time and Money-Saving Kinks

In this section you profit by the experience of other radio men. These kinks are really valuable "short-cuts" which save much time and, very often, money. They are "pet" ideas put into practice.

**Important Articles Which Have Appeared in
RADIO-CRAFT**

General Interest Articles

Design of Transformers for Class "AB" and "B" operation—A table of Inter-Electrode Capacities for 30 different tube types—How to make a Floating-Grid Relay—Construction of a modern High-Fidelity Amplifier—How to get DX on your All-Wave Radio—Making a 5-meter Transceiver for use in car or boat.

New Tubes Developed in 1936

Characteristics of the Newest Receiving Tubes of all manufacturers, giving uses, characteristics, present equivalents (if any) and all pertinent data.

RADIO-CRAFT

99 Hudson Street New York, N. Y.

RADIO-CRAFT, 99 Hudson St., New York, N. Y.

Gentlemen: Enclosed you will find my remittance of One Dollar (\$1.00) for which enter my subscription to RADIO-CRAFT Magazine for Seven Months. Send me **ABSOLUTELY FREE, and POSTPAID**, my copy of 1937 RADIO REFERENCE ANNUAL.

Name

Address

City State
(Send remittance by check or money order. Register your letter if you send cash or unused U. S. Postage Stamps.)
RC-1237

is then connected to the "B+Hi" binding post on the strip. This takes care of the temporary connections. Finally, connect all the negative sides of C1, C2 and C3, together to the common "B-". With this arrangement, the testing system which is still connected to the "B-" and "B+Var." binding posts, is now across part of the output from the filter.

Turn the power on, and note again the lighting of the neon bulb and the hum from the loudspeaker. Record in the Table of Data.

(5) *Varying the Voltage*—Leaving all connections as they are, turn the knob of P1 slowly back from its maximum position, observing the effect on the neon lamp. The point on the dial where the neon lamp extinguishes is approximately 70 V. It will thus be seen that the voltage control can be made to vary the voltage from 0 to a maximum of about 150 V. in this case (with the load of the neon tube and loud speaker combination). The full voltage available from the "B+Hi" binding post is not tested here, as this will be done in a later Experiment using meters. Generally speaking, it can be considered to be from about 450 V. at no load current, to about 250 V. at a full load of 80 milliamperes (or ma.).

CONCLUSION

This power supply is a device for converting the current from the 110-volt A.C. line into currents suitable for the operation of the vacuum tube. It supplies "A" current for the heaters at 6.3 V. A.C., and also, after rectification and filtering, supplies "B" current for the plate at about 450 V., practically pure D.C.

QUESTIONS*

1. To supply A.C. voltage for the heaters or "A" supply, the original 110 V. A.C. must be: (rectified; filtered; stepped-down.)
2. To change A.C. to pulsating D.C. the current must be: (rectified; filtered; stepped-down.)
3. To smooth away the pulsations into pure D.C., the current must be: (rectified; filtered; stepped-down.)
4. Pulsating D.C. differs from A.C. because: (it does not change; it never reverses its direction; it causes no hum.)
5. The original output of any rectifier is (A.C.; pulsating D.C.; pure D.C.).

*Answers to these questions appear on Pg. 380. School Radio Clubs are invited to write to the editors concerning the use of these Experiments by club groups.

LIST OF PARTS

- One United Transformer Co. power transformer, type UH1, 600 V. at 50 ma., 6.3 V. at 2 A., and 5 V. at 2 A., P.T. (Note: If it is desired to have 2.5 V. available for heater supply in addition to 6.3 V., use type UH2.)
- Two United Transformer Co. filter chokes, type PC6, 12 hy. at 60 ma., Ch.1, Ch.2;
- Three Solar ultra-compact electrolytic condensers, type LG5-8, 8 mf., 450 V. (working), C1, C2, C3.
- One Solar tubular paper condenser, type S-0267, 1 mf., 400 V., C4;
- *One 4-Prong socket, sub-panel, S;
- *One fixed resistor, type J, 10,000 ohms, 12 W., R1;
- *One power potentiometer, type P, 20,000 ohms, 12 W., P1;
- One power switch, labeled on-off, moving arm insulated, Sw.;
- One fuse and mount, automobile type, 2 A., F;
- One line cord and plug;
- One bakelite panel, 3 x 3 3/4 x 1/4-in.;
- *One dial plate, type 1179, 2 ins., 0-100 (325 deg.), and pointer knob, type 575;
- One binding post strip, 6-screw connections;
- *One metal chassis, punched for power supply, 6 x 9 x 2 1/2 ins.;

Accessories

- One Raytheon type 80 tube;
- *One neon bulb, 2 W., and *base socket, N;
- †*One dynamic loudspeaker, preferably permanent-magnet type, mounted in wooden cabinet, type 5BMCT, LS;
- *Names of manufacturers will be supplied upon receipt of a stamped and self-addressed envelope.
- †Denotes part used in previous experiments.

RE: "BUSINESS PROBLEMS OF THE SERVICE MAN"

Due to unforeseen circumstances this department by Jack Grand does not appear in this (December) issue; however, you will find it, as "The Case of Mr. Degan," in January *Radio-Craft*.



Jobbers everywhere... in every state in the Union... tell us that "QUALITY and PROFIT" conscious servicers are switching to C-D's. These smart servicers are taking advantage of the new highs in performance and dependability that C-D electrolytics are establishing on the most difficult jobs. No matter what the radio circuit—there's a rugged, dependable C-D condenser designed for it. The use of C-D in servicing means PROFITS... SATISFIED CUSTOMERS... PEACE OF MIND.

WORLD'S OLDEST and LARGEST EXCLUSIVE MANUFACTURERS OF CAPACITORS.
Catalog No. 151A describing in complete detail the entire line of C-D capacitors free on request.

Write to:
1014 Hamilton Blvd., So. Plainfield, N. J.
MICA • DYKANOL • PAPER
WET AND DRY ELECTROLYTICS

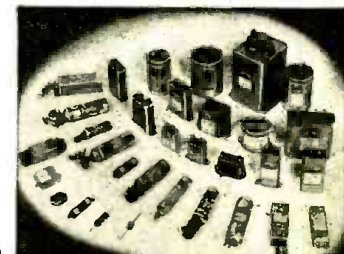

**CORNELL - DUBILIER
ELECTRIC CORPORATION**
South Plainfield, New Jersey

**SERVICEMEN
Get This New Self Selling
WIRE ASSORTMENT
DISPLAY**



It's a sensation! Birnbach leads again with this self-selling display. Attractive metal spools, including Push-back, Hookup, Colored Rubber Leadin, Fixture, Lamp Wire, etc., to resell at 39c.

MAGNET WIRE ASSORTMENT

On metal spools. Even sizes from 14 to 40, inclusive. Double Cotton, Plain Enamel, Double Silk. To resell at 25c each.

FREE Multicolored DISPLAY

One display given with each initial order for 100 spools. Display made of reinforced steel, mahogany crackle finish with attractive 3-color display. Your jobber can supply you, or write to us direct. Dept. S-8.

BIRNBACH RADIO CO.
145 HUDSON ST. BIRCO NEW YORK, N. Y.

Please Say That You Saw It in RADIO-CRAFT



BRINGS YOU ANY ONE OF THESE 4 FAMOUS RADIO BOOKS

RADIO FANS! Help yourselves to a radio education for the price of 10c per book. These books give you a good foundation towards the study of radio. You'll be amazed at the wealth of information contained in them. They are especially written for beginners but are useful review and reference books for all.

Each book contains 32 pages, profusely illustrated with clear, self-explanatory diagrams. They contain over 15,000 words of clear legible type. They are an education in themselves and lay the groundwork for a complete study of radio and electricity.

HOW TO BUILD FOUR DOERLE SHORT-WAVE SETS

Due to a special arrangement with the publishers of **SHORT WAVE CRAFT**, we present in this book complete details for building the Doerle sets, also an excellent power pack if you plan to electrify any of the sets. Contains **EVERYTHING** that has ever been printed on these famous receivers. These are the famous sets that appeared in **SHORT WAVE CRAFT**: "A 2-Tube Receiver that Reaches the 12,500 Mile Mark," by Walter C. Doerle; "A 3-Tube 'Signal Gripper,'" by Walter C. Doerle; "The Doerle"

HOW TO MAKE THE MOST POPULAR ALL-WAVE 1- AND 2-TUBE RECEIVERS

This book contains a number of excellent 1- and 2-tube sets, some of which have appeared in many issues of **RADIO-CRAFT**. These sets are not toys, but have been carefully engineered. They are not experiments. To mention only a few of the sets the following will give you an idea. The Megadyne 1-Tube Pentode Loudspeaker Set, by Hugo Gernsback—Electrifying The Tube Loudspeaker set, by W. P. Chesney—How to Make a Simple 1-Tube All-Wave Electric Set, by F. W. Harris—How to Build a Four-In-Two All-Wave Electric set, by J. T. Bernsley, and others.

ALTERNATING CURRENT FOR BEGINNERS

This book gives the beginner a foothold in electricity and radio. Electric circuits are explained. This includes Ohm's Law, alternating current, sine waves, volts, amperes, watts, condensers, transformers, motors and generators, A.C. instruments, house-wiring systems, electrical appliances and electric lamps. Here are some of the practical experiments which you can perform. Simple tests for differentiating between A.C. and D.C.; how to light a lamp by induction; making a simple electric horn; demagnetizing a watch; testing motor armatures; charging storage batteries from A.C. outlet; testing condensers with A.C.; making A.C. electromagnets; trying eggs on a cake of ice; making simple A.C. motors and many others. Has 42 illustrations.

ALL ABOUT AERIALS

In simple, understandable language this book explains the theory underlying the various types of aerials; the inverted L, the Doublet, the Doublet, etc. It explains how noise-free reception can be obtained, how low-impedance transmission lines work; why transposed leads are used. It gives in detail the construction of aerials suitable for long-wave broadcast receivers, for

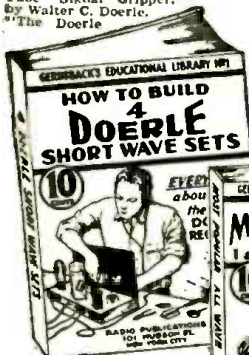

2-Tube* Adapted to A. C. Operation, "The Doerle 3-Tube 'Signal Gripper' Electrified," and "The Doerle 6 Coils 'Band Spread.'" Has 30 illustrations. **10c postpaid**

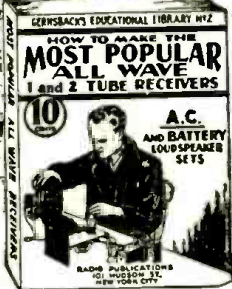

Has 30 illustrations. **10c postpaid**



Has 42 illustrations. **10c postpaid**

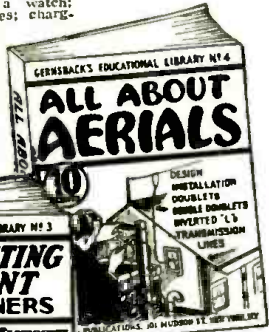

Has 66 illustrations. **10c postpaid**

RADIO PUBLICATIONS, 99A Hudson Street, New York, N. Y. RC-12-37

Please send immediately **POSTPAID** the books checked:

- No. 1—How to Build 4 Doerle Short Wave Sets.....10c
- No. 2—How to Make the Most Popular All-Wave 1- and 2-Tube Receivers.....10c
- No. 3—Alternating Current for Beginners.....10c
- No. 4—All About Aerials.....10c

I am enclosing.....c. the price of each book is 10c
 Send me **FREE** circular listing 48 new 10c publications

Name

Address

City State

(U. S. Coin or U. S. Stamps acceptable.) Books are sent postpaid.

Remember that each book has 32 pages and contains over 15,000 words. Each book has from 30 to 66 fine illustrations. **POSITIVELY THE GREATEST 10c VALUE IN RADIO BOOKS EVER OFFERED TO THE PUBLIC.**

If you do not think that these books are worth the money asked for them, return them within 24 hours and your money will be instantly refunded.

Send for our FREE circular listing 48 new 10c Publications

RADIO PUBLICATIONS
 99A Hudson St., New York, N. Y.

Vest Pocket Adding Machine

Sturdy Steel Construction. Lifetime Pocket Companion. Adds, Subtracts, Multiplies, Divides. Capacity, 999. 999.99. A real machine—guaranteed 9 years. Send name and address. We ship immediately. On delivery, pay postman \$2.50 (plus few cents post-age). Foreign countries send cash.) Your money back after 10 days trial if not satisfied. Thousands of satisfied users. Send no money. Total Send for Special Offer. Cost for to agents.

Free \$2.50 Trial

TAVELLA SALES CO., 21 West Broadway, New York, N. Y.

PATENTS—TRADE MARKS

All cases submitted given personal attention by members of the firm.

Form "Evidence of Conception" and instructions

"How to Establish Your Rights"—Free

LANCASTER, ALLWINE & ROMMEL
 PATENT LAW OFFICES
 436 Bowen Bldg. Washington, D. C.

CLASSIFIED ADVERTISEMENTS

Advertisements in this section are inserted at the cost of twelve cents per word for each insertion—name, initials and address each count as one word. Cash should accompany all classified advertisements unless placed by a recognized advertising agency. Not less than ten words are accepted. Advertising for the Jan., 1938, issue should be received not later than Saturday, Nov. 6, 1937.

DOGS

TERRIERS; ALSO BULL PUPS. SHIP ANYWHERE.
 Rob Tonn, Dallas, Texas.

ELECTRICAL SUPPLIES

HUNDREDS OF NEW, UNUSUAL, HARD-TO-GET electrical items, replacement parts and supplies. Send for free Wholesale catalog. Autopower, 409 South Hoyne Ave., Chicago.

RADIO

STEEL AND ALUMINUM CHASSIS, PANELS, cabinets, Any size. Holes punched as ordered. Send sketch for estimate. R. H. Lynch, 970 Camulos, Los Angeles, Calif.

THE LATEST RADIO EQUIPMENT

(Continued from page 352)
NEW TUBE AND SET TESTER IS VERITABLE SERVICE SHOP (1502)
 (Radio City Products Co.)

HERE IS a comprehensive multi-tester having 30 ranges and functions. All types of tubes may be tested, with separate function and component tests, under R.M.A. conditions. Meter is 2,000 ohms/volt type. Free-reference selection of any tube terminals, *individually*, for filament tests. Hot leakage, open and short tests of all elements with neon indication up to 0.25-meg.; includes hum test—the ultimate cathode-leakage test—and noise test (for each element; standard jack is provided for earphone or amplifier connection). Quick reference charts and a limited number of controls speed tests. Both instrument- and meter-fuse protection. Spare voltage taps and circuits provide against obsolescence. Meter test of electrolytic condenser leakage; neon lamp test for paper and mica condensers. Condenser open and short test. Ranges: A.C. voltage, 0-5-25-125-500-1,250; D.C. voltage, 0-5-25-125-500-1,250; ohms, 0-100 and 0-25,000; megohms, 0-2.5 and 0-25; microamperes, 0-500; D.C. milliamperes, 0-5-25-250; D.C. amperes, 0-2.5 and 0-25 (permitting tests of vibrators of all types); decibels, -15 to +10.

DIRECTIONAL CRYSTAL MICROPHONE (1503)
 (The Turner Co.)

DUE TO rear pickup being greatly reduced, feedback effects have been considerably minimized, in this new directional crystal microphone for ham use. Output level is -55 db. Shockproof interior floats inside the case.

IMPROVED PLAYBACK NEEDLE (1504)
 (Recoton Corp.)

DESIGNED for use on any material, including acetate, this new playback needle is said to result in a scratch level that is "lower than with any other needle" without loss of the high frequencies. Record wear is reduced.

A.C.-D.C. METER (1505)
 (Million Radio and Television Labs.)

THIS 20,000 ohms/volt (special high-torque movement) meter has built-in test leads; and switch control of the following ranges: 0-3-30-300-900 V., A.C. and D.C.; 0-60-300 microamperes D.C.; 0-30-300-600 ma., D.C.; 0-10,000 ohms, 30 megs. (self-contained battery); direct-reading db. power level scale.

NOISELESS POTENTIOMETER—AT LAST! (1506)
 (International Resistance Co.)

BY MEANS of a spiral spring wire, positive and continuous electrical connection is obtained between the center terminal and the volume adjustment arm. Thanks to this replacement of slide and friction with solid, positive contact, there is no chance for noise to develop at this point where most control noises originate. This, together with the exclusive "knee action" 5-finger element contact, is double assurance that these new controls are exceptionally quiet, and permanently so.

- ANSWERS TO QUESTIONS ON EXPERIMENT 3 (see page 379)**
1. To supply A.C. voltage for the heaters or "A" supply, the original 110 V. A.C. must be (stepped-down).
 2. To change A.C. to pulsating D.C. the current must be: (rectified).
 3. To smooth away the pulsations into pure D.C., the current must be: (filtered).
 4. Pulsating D.C. differs from A.C. because: (it never reverses its direction).
 5. The original output of any rectifier is: (pulsating D.C.).

Please Say That You Saw It in RADIO-CRAFT

NO REASON *Why*
YOU SHOULDN'T PROFIT
FROM *Servicing Tips*
FEATURED IN BERNSELY'S
Official Radio Service Handibook

PROFESSIONAL men like to learn new things about their business—and we've found that radio men are wise to the "tricks" also. That is why thousands of radio Service Men constantly refer to Bernsley's **OFFICIAL RADIO SERVICE HANDBOOK**. It has the servicing tips your business requires—and many more besides. The **HANDBOOK** is the "by word" among crackerjack radio men.

HERE ARE THE OUTSTANDING FEATURES
Special section exceeding 250 pages of Operating Notes for Standard Receivers • Circuit Theory and Analysis • Servicing Equipment • Standard and Specialized Receiver Installations • Modernization and Conversion Data • Social and Economic Problems of the Service Man. In all there are over six hundred topics covered—with illustrations and photographs aplenty.

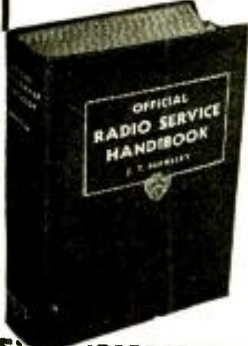

It's a text book every radio Service Man needs—it's a comprehensive volume of

Over 1,000 Pages
Over 1,000 Illustrations

It is sturdily bound to assure rough usage—and it has an attractive, stiff linen cover with title stamped in gold letters. Conveniently sized—6 x 9 inches—and weighs over two pounds.

RADCRAFT PUBLICATIONS, Incorporated
99 Hudson St., New York, N. Y.

RADCRAFT PUBLICATIONS, Inc. RC-1237
99 Hudson St., New York, N. Y.
Gentlemen: Please send me on **FIVE-DAY APPROVAL** One Copy of BERNSELY'S **OFFICIAL RADIO SERVICE HANDBOOK**. If I retain the book, I will remit promptly the amount of \$4.00. Should I return the book, I pay only the mailing costs to you.

Name

Address

City State

Employed by

(This offer is good only in U.S.A.)

Formulas and Recipes FOR THE PRACTICAL MAN

CONTENTS OF BOOK

1. Adhesives; Glues, Cements, Gums, Mucilages, Lubricants, 2. Cleansing; Stain Removers, Paint Removers, Bleaches, Cleaning Fluids, 3. Metal Craft; Coloring, Oxidizing, Plating, Repairing, Welding, Polishes, Alloys, Solders, Amalgams, 4. Paints; Colors, Stains, Varnishes, Enamels, Luminous Paint, Washable Paint; Paint-Removing, Waterproofing, Fireproofing, 5. Glass-Working; Cutting, Drilling, Boring, Bending, Blowing, Etching, Engraving, Frosting, Silvering, etc. 6. Wood-craft; Fillers, Fireproofing, Acid-proofing, Waterproofing; Furniture Polishes, Finishes, etc. 7. Inks; Recipes, Eradicators, Ink Stain Removers; Special Inks; Colored, Indelible, Sympathetic, Invisible, Hectograph, 8. Photography; Developers, Emulsions, Fixers, Sensitizing, Toning, Printing, Photographic Paper, Blueprint Paper, 9. Antidotes for Poisons, Remedies for Burns and Scalds, Disinfectants, First-Aid in Accidents, Emergency Remedies, Home Remedies, 10. Preparation, Manipulation, Handling, Mixing, Measuring, Weighing, Filtering, Straining Solutions; List of Technical Substances; Emulsifying; Use of Hydrometer, Use of Thermometer; Tables of Weights and Measures, Decimal System, Useful Tables.

Price 50c Postpaid

TECHNIFAX

Division RC-1237

558 W. WASHINGTON BLVD., CHICAGO, ILL.

INTRODUCING—"AUDIO-SPECTRUM CONTROL"

(Continued from page 347)

(1) For the ideal recreation of recorded audio signals, it is to be assumed that all deficiencies of the recording system will be compensated-for during reproduction. Obviously a wide range of frequency control is required to neutralize all frequencies attenuated or accentuated during recording and playback.

(2) Assuming for a moment that present recording systems are ideal, the frequency response characteristics of microphones, speakers and other accessories still contribute frequency distortion.

(3) Further extension of our supposition that all auxiliary components have attained an ideal state of perfection, the problem of studio acoustics will still affect the frequency response of our ideal system.

(4) Even if all studios were standardized acoustically, the physiological reaction of individual listeners will not be alike. In fact, the response characteristics of each ear of an individual listener will sometimes vary enough to offset all efforts exerted in the design of a flat-frequency-response audio system.

(5) On top of all this, when one realizes that the response characteristic of the average ear is far from a straight line in nature (maximum sensitivity lies between 1,000 and 5,000 cycles), it becomes readily apparent that some flexible method of controlling the frequency response characteristics of our reproducing system is not only desirable but a practical necessity particularly if pleasing reproduction is desired for all types of signal amplification under any local acoustic condition.

Therefore, a desirable method of control should provide for the accentuation of a series of predetermined audio bands each of sufficient width so that additively they cover the entire audio range. As each band width would require a separate control, the spectrum should be divided into a minimum number of bands.

For simplicity of manipulation, a *master control* should be incorporated so as to avoid the necessity of resetting all band controls for each different volume level. In operation the master volume control should have the same effect as equally increasing or decreasing all band controls.

WIDE-RANGE THRESHOLD CONTROL

As complete suppression of any one band would prove to be detrimental to quality reproduction a wide-range threshold control should be incorporated so as to vary the minimum accentuation of all band controls. This feature is particularly desirable if any unit in the audio system resonates at some fixed frequency. Proper adjustment of the threshold control will prevent undue overload distortion at a given resonating frequency when the band control (in which the resonating frequency lies) is turned to maximum.

As the ear response varies most at both extremes of the hearing range it was decided to arbitrarily divide the audio band into the following 3 sub-ranges: (1) Low Frequency (16-250 cycles); (2) Middle Frequency (250-5,000 cycles); and (3) High Frequency (5,000-20,000 cycles). This empirical division need not be followed, since any other ratio of division may be utilized depending upon the type of compensation required for any given condition.

THE CIRCUIT IN A NUTSHELL

Essentially, the audio spectrum control circuit, as shown in heavy lines in Fig. 2A, splits the input signal into 4 branches. The first 3 branches are fed through a "low-pass filter" (for low-frequency accentuation), a "band-pass filter" (for middle-frequency accentuation), and a "high-pass filter" (for high-frequency accentuation), respectively. The remaining branch passes through a wide-range control, T.V., for controlling the operating threshold of all band controls.

This type of circuit has the distinct advantage that it does not utilize "losser" circuits and that it does not utilize resonating-type accentuating circuits which have control over a limited and narrow audio band. Of course, the usual boominess, caused by the shock excitation of tuned resonating circuits, is absent. The ability of being able to add-to or accentuate

(Continued on following page)



Chassis Cradle

PREVENTS DAMAGE—
HOLDS CHASSIS
IN ANY POSITION

Only \$4.85 at your distributor

Holds any make or model radio chassis in desired position for testing, aligning, repairing, replacing parts, etc. Clamps hold chassis in vise-like grip. Prevents danger of accidental damage to coil assemblies, tubes, etc. Allows both hands free for work. Puts repair jobs on a production basis. Is very desirable for displaying radio chassis. Made of steel—cadmium plated. Order today through your distributor.

ACRO TOOL & DIE WORKS

1401 Wilson Ave., Chicago, Ill.



announces a complete line of

TRANSMITTING CAPACITORS

OIL—PAPER
and
MICA TYPES

Write for Complete Catalog

SOLAR MANUFACTURING CORP
599-601 Broadway, New York, N. Y.

\$500,000 GENUINE
MAJESTIC-GRIGSBY GRUNOW
REFRIGERATOR &
RADIO PARTS.
FOR MODELS
PRIOR TO
1936



UNITS
GUARAN-
TEED 18 MONTHS.
SEND FOR PRICE LIST.
G & G GENUINE MAJESTIC RE-
FRIGERATOR & RADIO PARTS SERVICE
5801 W. DICKENS AVE. CHICAGO, ILL.

FOR TEST EQUIPMENT—

BUY RCA RCA makes all types of test equipment—including the popular Cathode Ray Oscilloscope and Oscillator. RCA Test Equipment is used in the RCA instrument factories—by major set manufacturers and thousands of service engineers—*proof* that it's good! Available at moderate cost. For full details write to Parts Division, RCA Manufacturing Co., Inc., Camden, New Jersey. A service of the Radio Corporation of America.

Please Say That You Saw It in RADIO-CRAFT

AS NEW TODAY
AS TOMORROW'S NEWS:

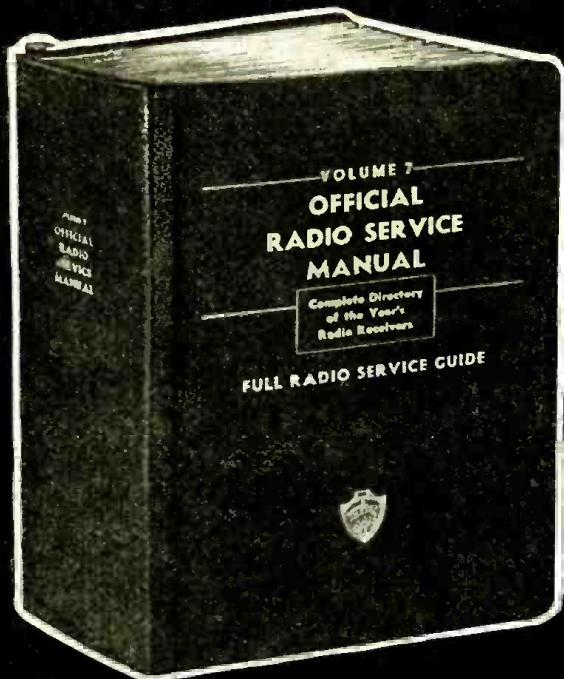

VOLUME 7
OFFICIAL RADIO SERVICE MANUAL

OVER
1,800
PAGES
★
OVER
3,000
ILLUSTRATIONS
★
SIZE: 9" x 12"

COMPARE other service manuals with the new GERNSBACK OFFICIAL RADIO SERVICE MANUAL (Volume 7) as it is published today. You'll find the GERNSBACK MANUAL, by far more complete in service information — more up-to-the-minute with present-day receiver diagrams—and published entirely differently than in previous years.

Most important of many innovations are the month-to-month installment method of publishing Volume 7—and the deferred payment plan which makes it convenient for every Service Man to own radio's greatest of service manuals. Write today for descriptive literature which gives complete information about Volume 7 of the OFFICIAL RADIO SERVICE MANUAL—and the plan which tells how to pay-as-you-compile your Manual. Mail the coupon below—**TODAY!**

RADCRAFT PUBLICATIONS, Inc.
99 Hudson Street, NEW YORK, N. Y.

RADCRAFT PUBLICATIONS, Inc., 99 Hudson Street, New York, N. Y. RC-1237

Gentlemen: Please send me descriptive literature on Volume 7 of the GERNSBACK OFFICIAL RADIO SERVICE MANUAL—and details for buying this edition on the deferred payment plan.

Name

Address

City State

Please Say That You Saw It in RADIO-CRAFT

(Continued from preceding page)

any portion of the audio spectrum, and to maintain that accentuation flat within the selected portion of the A.F. range, brings a new type of fidelity control to the audio field.

DESIGNING THE FILTERS

The general design follows conventional engineering practice. In order to attain a flat-line response curve, when all filters are in the circuit, it is important that the slope of the cut-off characteristic of the filters complement each other. The following formulas are included only for the technician who wishes to design his own high-pass, low-pass, and band-pass filter, shown in detail in Fig. 3, to cover any desired frequency range.

Lo-Pass Filter. The fundamental circuit of the lo-pass filter is illustrated in Fig. 3A. The inductances are determined by the following formula:

$$L_1 = \frac{Z}{\pi F} \text{ henrys}$$

Inasmuch as the circuit employed is of the π type, the value of the inductance above calculated, should be divided by 2. The value of the shunt condensers may be found from the following formula:

$$C_2 = \frac{1}{\pi F Z}$$

F = cut-off frequency
C = capacity in farads
L = inductance in henrys
Z = the iterative (That is, the same impedance is reflected from either end of the filter.) impedance of the filter

Hi-Pass Filter. The hi-pass filter follows the same design principle and is similar to the circuit shown in Figure 3B. The condenser and inductance values may be found from the following formulas:

$$L_2 = \frac{Z}{4\pi F} \text{ henrys} \quad C_1 = \frac{1}{4\pi F C}$$

Band-Pass Filter. The circuit employed in the band-pass filter is similar to the schematic shown in Fig. 3C. Constants for the various condensers and inductances may be found from the following formulas:

$$C_1 = \frac{F'' - F'}{4\pi (F'' - F'') Z} \quad L_2 = \frac{(F'' - F') Z}{4\pi (F' - F'')} \\ L_1 = \frac{Z}{\pi (F'' - F')} \quad C_2 = \frac{1}{\pi (F'' - F') Z}$$

F' = lower cut-off frequency
F'' = higher cut-off frequency

THE MIXER AND AMPLIFIER CIRCUITS

It will be noted from the schematic circuit, Fig. 2, that the mixer arrangement provides for independently varying the level of the various signals passing through their respective filters. The unlimited degree of flexibility offered by this type of audio spectrum control provides for the addition or subtraction of frequencies in any one or more of the bands to any recording or other program passing through the amplifier.

The circuit of the amplifier also follows conventional high-fidelity design. It will be noted that 2 microphones may be mixed with a phono pickup. The 2-position input preamplifier utilizes two 6J7s which are in turn fed into the 6N7 mixer which supplies the band-pass system with its signal energy. The two 6N7s utilized in the output of the filter feed the 6F6 driver which utilizes a parallel-resistance-feed plate circuit to keep direct current from the primary of the driver transformer. Inverse feedback is employed in the output stage in a conventional manner so as to reduce the output hum and distortion caused by resonance effects in the speaker load circuit.

(Continued on opposite page)

NEW TUBES FOR THE RADIO EXPERIMENTER

(Continued from page 373)

the "supervisory control tube" shown in Fig. D may be connected across the line and the 3rd connection grounded, as shown in Fig. 2, to serve as protection to equipment and operator in the event of surges exceeding 300 V.

The device consists of 3 graphite electrodes mounted in a gas-filled bulb. The tube may be used in place of the more familiar overload relays which require re-setting. The protector tube will stand considerable overload, shunting the overload to ground, without being damaged.

The capacity of this protector, as the characteristic data indicate, is 50 A. for 2 seconds. Under these conditions the bulb has a life of many severe discharges without change in characteristics. It is recommended that a resistor of 60 ohms be placed in series with the tube to prevent possible short-circuit of the supply source through the tube when discharging any disturbance; also, fuse the line with 10 A. fuses as shown in the diagram. Characteristics follow:

- Breakdown voltage, 300 to 500 V.
- Max. discharge (2-sec. periods), 50 A.; (10-min. periods), 7 A.
- Typical operating line voltage, A.C., r.m.s., 115 V.
- Average arc drop, 20 to 30 V., D.C.
- Max. short-circuit current at which tube will clear at first current zero, at 230 V., 10 A.; at 115 V., 15 A.

*Pressure-Indicating Tube: Type WL-762. Experimenters who are already dabbling in vacuum-tube work, or who plan to take up the study either in a school lab. or at home, will be interested to know about the means, illustrated in Fig. D, of obtaining indications of changes in atmospheric pressure electronically.

The "pressure-indicating tube" consists essentially of a long platinum ribbon suitably mounted inside of a glass bulb. The tube is connected by means of the usual tubing to the vacuum system in which measurements are desired and changes in the heat conductivity between the filament wire and the bulb to the atmosphere can be used to obtain readings indicating the amount of gas remaining in the exhaust system.

One circuit in which this tube, together with a second, may be used to particular advantage is shown in Fig. 3. The supply voltage (or current) must be kept absolutely constant. Meter M is a 0-10 ma. unit. Item II is a double-stack dry-disc rectifier; meter V monitors the output to obtain about 12 V. Meter M may be calibrated to read atmospheric pressure directly (for instance, down to 1 micron).

The principle of operation of this tube is interesting. At atmospheric pressure there is a definite rate of cooling of the heated filament by

the particles of air which carry the heat from filament to the bulb. As the amount of air in the tube is reduced the rate of conduction of heat from the filament to the bulb decreases, resulting in an increase in filament temperature. Hence the resistance of the filament increases, causing the current in the filament circuit to decrease. The increase in resistance continues as the vacuum conditions are improved or as the air pressure and consequently the number of molecules of air are decreased. The same phenomenon occurs if the tube is used in measuring pressure conditions of gases other than air.

Base connections are shown in Fig. 1; the operating current range is approx. 0 to 0.3-A.

ULTRA-SHORTWAVE TUBE

U.-H.F. High-Mu and High-Vacuum Transmitting Triode; R.F. Amplifier, Oscillator and Class B Modulator: Type 833. A minimum amount of insulation within the tube, low internal lead inductances, and a post terminal construction which makes bases unnecessary, are features that enable the new type 833 tube to develop high power on 30 to 100 megacycles (10 meters to 3 meters).

As a result of its construction, the 833 provides high plate efficiency at moderate voltages. For example, it is capable of giving in broadcast service a carrier output of 635 W. at 2,500 V. on the plate, and with this carrier output, can be modulated 100%. In other services, such as police transmitters, diathermy apparatus, aviation transmitters, and experimental ultra-high frequency transmitters (for experiments with radio-controlled equipment, etc.), the 833 also provides excellent efficiency.

Terminal connections are shown in Fig. 1. (Data courtesy RCA Radiotron.)

RECTIFIER TUBE

*Mercury-Vapor Rectifier: Type 2-RA-15. This heavy-duty rectifier is designed to deliver very high values of pulsating direct current; it is thus suitable on a bench "A" supply for testing radio sets without resorting to a storage battery for filament D.C. It also may be used to supply D.C. for energizing field coils in high-grade P.A. systems. Tube life is about 2,000 operating hours. Characteristics follow:

- Filament voltage, 2.5; current, 16 A.; heating time, 2 to 3 mins.
- D.C. average output, 15 A.; crest, 45 A.
- Arc drop, 5 to 8 V.
- Pick-up voltage, 8 to 11 V.
- D.C. output voltage, 60 (max.); D.C. crest inverse voltage, 200 V. (max.).

*Names of manufacturers will be supplied upon receipt of a stamped and self-addressed envelope.

ESSENTIAL

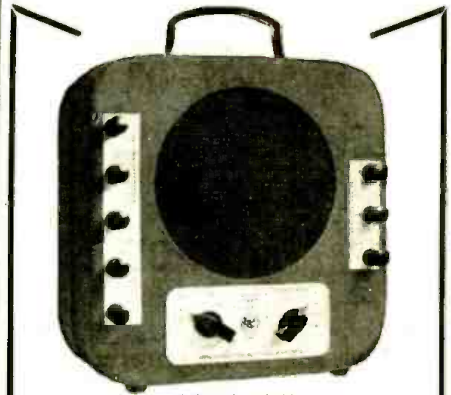

Model NKM 3600

TO ALL RADIO TECHNICIANS

Nokoil Multi-Test Speaker

Tests all AC and DC Radios.

- Tests automobile radios without removing Speaker
- Easily locates faulty speaker in a line of PA units
- Checks approximately the impedance into which an amplifier is designed to operate.
- Handsome Steel Carrying case with soft Suede finish

LIST PRICE **\$36.00**

Write for complete description and name of our nearest distributor. Wright-DeCoster Distributors are always anxious to cooperate.

WRIGHT-DECOSTER, Inc.

2251 University Ave., St. Paul, Minnesota.
Export Dept.—M. Simons & Son Co., New York.
Cable Address: "Simonrice."
Canadian Representatives:
Wm. F. Kelly Co., 1207 Bay St., Toronto, Ontario
Taylor & Pearson, Ltd., Edmonton, Alta.



LOWEST PRICES

GUARANTEED QUALITY

FASTEST SERVICE

The New 1938 Radolek Radio Profit Guide contains complete showings of Radio Repair Parts, Radio Receivers, Public Address Amplifiers, Speakers, Microphones, Test Instruments, Technical Books, Special Tools. Leading Standard Brands! Everything you need in the Radio Business all at Lowest Prices. You save money at Radolek!

Every item you get from Radolek is guaranteed. It must be right or we make it right. Standard merchandise produced by leading manufacturers with Radolek's guarantee added!

Everything in Radio promptly when you want it—and exactly what you want. Radolek's efficient organization insures you the fastest service in the Radio business. 25,000 Servicemen customers depend on Radolek service and benefit by Radolek's LOWEST PRICES.

Send Now for Radolek Radio Profit Guide. It will help you make money.

RADOLEK

601 W. Randolph, Chicago, Dept. C-12

Send the 1938 Radolek Radio Profit Guide.

Name _____
Address _____
City _____ State _____
Serviceman? () Dealer? () Experimenter? ()

FACTORY TO YOU

NEW REMINGTON NOISELESS PORTABLE!



10¢ A DAY

Famous Remington Noiseless Portable that speaks in a whisper, only 10¢ a day, direct from factory. Standard keyboard. Automatic ribbon reverse. Variable line spacer and all the conveniences of the finest portable ever built. PLUS the NOISELESS feature. Act now. Send coupon TODAY for details.

You don't RISK a Penny

We send you Remington Noiseless Portable for 10 days' free trial. If not satisfied, send it back. We pay all shipping charges.

FREE Typing Course and Carrying Case

You will receive FREE, a complete simplified home course in Touch Typing. Also FREE, a handsome, sturdy carrying case. No obligation. Mail coupon for full details—NOW

Remington Rand Inc., Dept. 189-12
465 Washington St., Buffalo, N. Y.

Tell me, without obligation, how to get a new Remington Noiseless Portable, plus Free Typing Course and Carrying Case, for 10¢ a day. Send Catalogue.

Name _____
Address _____
City _____ State _____

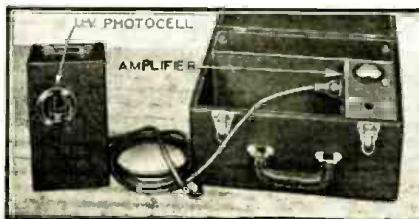

Fig. E. Unit using ultra-violet photocell.

INTRODUCING "A.S.C."

(Continued from preceding page)

THE POWER SUPPLY

In order to minimize any inductive hum pick-up effects, between the power supply and the band-pass filter units, a separate power pack is utilized. It will be noted from a casual observation of the power supply circuit, Fig. 2B, that a stabilized voltage supply system is employed in order to insure constant screen-grid voltage to the beam-type power output tubes. This feature eliminates screen-grid circuit distortion, and assures the full 32-watt output with less than 2% total harmonic content. An output of 40 watts is easily attained.

By following the same general design principles, a 60-watt class AB amplifier may also be constructed utilizing the same band-pass filter circuit principles.

The author will be pleased to help any Radio-Craft reader to own an amplifier of this type.

Please Say That You Saw It in RADIO-CRAFT

F OR THE RADIO SERVICE MAN, DEALER AND OWNER

The man who enrolls for an I.C.S. Radio Course learns radio thoroughly, completely, practically. When he earns his diploma he will KNOW radio. We are not content merely to teach the principles of radio, we want to show our students how to apply that training in practical, every-day, radio service work. We want them to make good, to make money, to be successful radio experts.

INTERNATIONAL CORRESPONDENCE SCHOOLS

Box 6676-D, Scranton, Penna.
Explain fully about your course in the subject marked X:

- RADIO
- EXPERIMENTAL TELEVISION
- SOUND TECHNICIANS
- AVIATION SECTION OF RADIO OPERATING

Name _____ Age _____
Address _____

PRICES REDUCED

on two Brush microphones — BR2S and B-1. If your jobber can't supply you, write us.

THE BRUSH DEVELOPMENT CO.
3312 Perkins Ave., Cleveland, Ohio

BOOK REVIEW

ELECTRICAL OCCUPATIONS, by Lee M. Klinefelter. Published by E. P. Dutton & Co., Inc., New York. Size, 5 1/4 x 7 1/2 ins., 227 pages, about 70 illustrations. Price \$2.

This, as the author states, is an excellent survey of the vocational opportunities for boys in the electrical field. Valuable information is given as to the requirements, and the prospects as to salaries, chances of promotion, etc., concerning the following occupations: electrical engineers, power station operators, electricians, electrical draftsmen, battery men, motion picture operators, radio Service Men, ship radio operators, broadcast radio operators, naval electricians, army specialists, telegraphers, telephone men, and electric welders. Although failing completely to mention the possibilities in the important fields of electronics and public address, and although touching incompletely on the remaining phases of radio, the book is strongly recommended to every young man with leanings toward things electrical, as the first real down-to-earth electro-vocational book.

STATEMENT OF THE OWNERSHIP, MANAGEMENT, CIRCULATION, ETC., REQUIRED BY THE ACTS OF CONGRESS OF AUGUST 24, 1912, AND MARCH 3, 1933.

Of RADIO-CRAFT, published monthly at Springfield, Mass., for October 1, 1937.
State of New York
County of New York } ss.

Before me, a Notary Public in and for the State and county aforesaid, personally appeared H. Gernsback, who, having been duly sworn according to law, deposes and says that he is the editor of *Radio-Craft* and that the following is, to the best of his knowledge and belief, a true statement of the ownership, management (and if a daily paper, the circulation), etc., of the aforesaid publication for the date shown in the above caption, required by the Act of August 24, 1912 and as amended by the Act of March 3, 1933, embodied in section 537, Postal Laws and Regulations, printed on the reverse of this form, to wit:

1. That the names and addresses of the publisher, editor, managing editor, and business managers are: Publisher, Radercraft Publications, Inc., 99 Hudson St., New York, N. Y.; Editor, H. Gernsback, 99 Hudson St., New York, N. Y.; Managing Editor, R. D. Washburne, 99 Hudson St., New York, N. Y.; Business Managers, none.

2. That the owner is: (If owned by a corporation, its name and address must be stated and also immediately thereunder the names and addresses of stockholders owning or holding one per cent or more of total amount of stock. If not owned by a corporation, the names and addresses of the individual owners must be given. If owned by a firm, company, or other unincorporated concern, its name and address, as well as those of each individual member, must be given.) Radercraft Publications, Inc., 99 Hudson St., New York, N. Y.; H. Gernsback, 99 Hudson St., New York, N. Y.

3. That the known bondholders, mortgagees, and other security holders owning or holding 1 per cent or more of total amount of bonds, mortgages, or other securities are: (if there are none, so state.) None.

4. That the two paragraphs next above, giving the names of the owners, stockholders, and security holders, if any, contain not only the list of stockholders and security holders as they appear upon the books of the company but also, in cases where the stockholder or security holder appears upon the books of the company as trustee or in any other fiduciary relation, the name of the person or corporation for whom such trustee is acting, is given; also that the said two paragraphs contain statements embracing affiant's full knowledge and belief as to the circumstances and conditions under which stockholders and security holders who do not appear upon the books of the company as trustees, hold stock and securities in a capacity other than that of a bona fide owner; and this affiant has no reason to believe that any other person, association, or corporation has any interest direct or indirect in the said stock, bonds, or other securities than as so stated by him.

5. That the average number of copies of each issue of this publication sold or distributed, through the mails or otherwise, to paid subscribers during the twelve months preceding the date shown above is _____ (This information is required from daily publications only.)

H. GERNSBACK, Publisher.
Sworn to and subscribed before me this 30th day of Sept., 1937.

MAURICE COYNE, Notary Public.
Notary Public, N. Y. Co. No. 500
(My commission expires March 30, 1938.)

ADVERTISERS' INDEX

A	
Aero Tool & Die Works.....	381
Aerovox Corporation.....	372
Akrad Products Company.....	371
Allied Radio Corporation.....	363
American Ired Cross.....	375
American Television Institute, Inc.....	371
Audlier Co. of America.....	376
Arrow Sales Corporation.....	374
Autopower.....	378
B	
Birnbarh Radio Company.....	379
The Brush Development Company.....	381
Burstein-Applebee Company.....	375
C	
Cinaudagraph Corporation.....	370
Central Radio Laboratories.....	368
Classified Section.....	359
Continental Carbon, Inc.....	379
Cornell-Dubilier Corporation.....	379
Coyne Electrical School.....	323
E	
Electrical Salvage Company.....	360
Electronic Products Company.....	360
Electronic Publishing Company.....	364
G	
G&G Genuine Majestic Refrigerator and Radio Parts Service.....	381
Gadgets Magazine.....	363
Goldentone Radio Company.....	375
Greupark Company.....	377
H	
Hannarlund Mfg. Company.....	378
Hygrade Sylvania Corporation.....	362
I	
Imperial Model Company.....	378
International Correspondence Schools.....	381
International Resistance Company.....	361
K	
Kenyon Transformer Company, Inc.....	369
L	
Lancaster, Allwine & Hommel.....	380
Lincoln Engineering School.....	378
M	
Metal Cast Products Company.....	371
Midwest Radio Corporation.....	371
Million Radio & Tel. Labs.....	373
Modell.....	365
N	
National Radio Institute.....	321
National Schools.....	376
National Union Radio Corp.....	373
New Ideas Magazine.....	376
P	
The Plan Shop.....	375
Precision Apparatus Corp.....	374
R	
Radio Corporation of America.....	Back Cover
RCA Institutes, Inc.....	375
RC A Manufacturing Company, Inc.....	381
Radio Circuit Company.....	368
Radio City Products Company.....	376
Radio Publications.....	380
Radio Service Institute.....	373
Radio & Technical Publ. Co.....	366, 376, 360
Radio Training Assoc. of America.....	372
Radiobek Company.....	383
Raytheon Production Corp.....	377
Readite Meter Works.....	367
Resonon Corporation.....	374
Remington Rand, Inc.....	383
John F. Rider.....	324
S	
Solar Manufacturing Company.....	381
Sprayberry Academy of Radio.....	365
Standard Transformer Corp.....	374
Superior Instrument Company.....	357
Suime Instruments Corporation.....	Inside Front Cover
T	
Tavella Sales Company.....	380
Technifax.....	381
Technix Company.....	378
William A. Thomas Company.....	375
Triplett Elect. Instr. Co.....	Inside Back Cover
The Turner Company.....	366
U	
Utah Radio Products Company.....	364
W	
Montgomery Ward & Company.....	369
Wellworth Trading Company.....	376
Weston Elect. Instr. Corp.....	375
Wholesale Radio Service Co., Inc.....	379
Wright-DeCoster, Inc.....	383
Z	
Zephyr Radio Company.....	373

(While every precaution is taken to insure accuracy, we cannot guarantee against the possibility of an occasional change or omission in the preparation of this index.)

25,000 OHMS PER VOLT

TRIPPLET

**DE LUXE
SET TESTER**

Entirely New

Modern Design
for Quick
Accurate Set
Testing



Model
1601
\$45.33

In Metal
Case

- D.C. Volts at 25,000 Ohms per Volt
A.C. Volts at 1,000 Ohms per Volt
Reads to 2000 Volts A.C. and D.C.
in 6 Ranges.
- Resistance Measurements to 20
Megohms.
- Condenser Tester to 30 Mfds.
- 50 Microamperes to 20 Amperes in
9 Ranges.
- Free Point Tester
- Incorporates Exclusive Plug-in
Type Copper Oxide Rectifier.
- New Single Zero Adjustment for
Ohmmeter.
- All A.C. Operated—No Batteries
Used.

Triplet's new DeLuxe Set Tester incorporates the very latest features. Ultra high class and professional appearance. Durable etched panel—natural silver background with sunken black lettering. Control knobs and other fittings are finished in red. The exclusive plug-in type copper oxide rectifier is the ap-

proved, most accurate method for rectification, with the newly added advantage of easy replacement due to accidental damage or overloading. Replaces as easily as removing an ordinary fuse. In leatherette case, as shown, \$49.33.

**TRIPPLET'S NEW
DE LUXE LINE OF
RADIO TESTERS
Sets A
"New High"
In Accuracy,
Appearance and
Practicability**

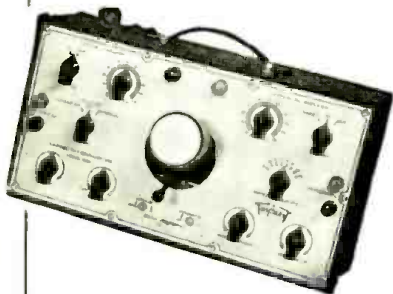

Other De Luxe Items

Model 1690 Oscilloscope . . .
With 2" screen . . . Exclusive Triplet turret type tube
mounting. Linear Sweep 15 to 20,000 Cycles . . .
Complete with tubes and instructions . . . In metal
Case \$47.00

Model 1630 . . . Outstanding Signal Generator for
extreme accuracy . . . Zero leakage . . . 100 K.C. to
30 M.C. in six ranges . . . Complete . . . In Metal
Case \$45.00

Model 1631 . . . Same as 1630 but in addition incor-
porates electronic frequency modulation . . . In Metal
Case \$55.00

Model 1670 . . . Vibrator Tester . . . Completely
tests all vibrators under actual performance condi-
tions . . . In Metal Case \$24.00

All DeLuxe Testers in two case styles: Sturdy metal
with black wrinkle finish. 14 1/2" x 7 3/4" x 4 1/2". Leather-
ette covered case has removable cover and compartment
for accessories, size 15 1/2" x 12" x 6 3/4".

TRIPPLET
Precision

ELECTRICAL INSTRUMENTS

THE TRIPPLET ELECTRICAL INSTRUMENT CO.

1612 Harmon Ave., Bluffton, Ohio

—Please send me more information on—Model 1601;

—Model 1690;—Model 1630;—Model 1631;—Model

1670. —I am also interested in—

Name

Address

City State

RCA All The Way



RCA engineers have continuous practical experience in every branch of radio. Through the National Broadcasting Company, RCA creates and broadcasts the majority of network programs. Through Victor, RCA has the benefit of 39 years' leadership in sound pro-

duction. RCA engineering, NBC broadcast skill, Victor mastery of tone are combined in every RCA product. This *complete* radio and sound experience—RCA All the Way—means better quality—*more* for your money! Let the RCA trademark be your buying guide!

RCA Radio and Sound Products Give You More for Your Money

For commercial sound equipment—BUY RCA!

For all types of commercial sound equipment—from tiny lapel microphones to giant sound systems—your best bet is RCA.



FREE! Send today for your copy of the new 36-page illustrated sound catalog "Sound by RCA" which contains pictures of RCA's varied types of sound equipment and complete information about the entire line. This catalog has been prepared especially for you—and is available without cost or obligation. Send your request to your nearest RCA Commercial Sound Distributor, or write direct to Camden, New Jersey.

395 is the name and price of this fine, new RCA Antenna System.

Everyone can afford the new RCA 395 Antenna System. Comes completely assembled and soldered. Is easily installed. Covers wide frequency range—140 to 23,000 kilocycles. Is doublet type—affording efficient pick-up. Stock No. 395. **Only \$3.95**

RCA presents the "Magic Key" every Sunday, 2 to 3 P. M., E. S. T., on NBC Blue Network.



For radio tubes—BUY RCA!

300,000,000 RCA radio tubes have been bought by radio users—*proof* of RCA quality.

The world's finest radio tubes bear the RCA trademark. This is proved by the fact that more RCA tubes have been sold than any other kind. In every type of radio and sound equipment RCA tubes are used. Radio manufacturers buy millions of these tubes each year for use in their instruments.

Why are RCA tubes used so extensively? There is only one answer. They offer better quality, better performance. Replace the weak tubes in your radio set with new RCA radio tubes. They give old radios new pep and power—bring listeners a new thrill.

For radio tubes, it pays to go RCA All the Way. First in Metal—Foremost in Glass—Finest in Tone.

For antenna systems—BUY RCA!

RCA Magic Wave Antenna System Reduces Noise—operates up to 16 radios at one time.

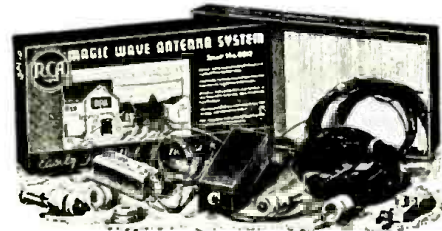

With this outstanding new antenna, noise is greatly reduced on both standard and international short wave bands from 530 to 23,000 kilocycles. Easy installation is another of its many fine features. Magic Wave Antenna, Stock No. 9812, is completely assembled and soldered at the factory. Comes to you complete, ready to install. List price \$6.95.

THE RADIO CORPORATION OF AMERICA RADIO CITY, NEW YORK

RCA Manufacturing Company, Inc.
RCA Communications, Inc.

National Broadcasting Company

RCA Institutes, Inc.
Radiomarine Corporation of America